

SIEMENS



LPB and BSB plants

Web server OZW672... V4.0 Commissioning instructions

OZW672.01
OZW672.04
OZW672.16

Siemens Switzerland Ltd
Infrastructure & Cities Sector
Building Technologies Division
Gubelstrasse 22
CH-6301 Zug
Tel. +41 41-724 24 24
www.siemens.com/sbt

© 2010-2012 Siemens Switzerland Ltd
Subject to change

Table of contents

1	Overview	7
1.1	Introduction	7
1.2	Display and operating elements.....	8
1.3	Web operation.....	9
1.3.1	User levels	10
1.4	Symbols, notations, abbreviations	11
1.4.1	Symbols	11
1.4.2	Notations	12
1.4.3	Abbreviations	12
2	Commissioning	13
2.1	Prerequisites	13
2.2	Getting started.....	14
2.2.1	Turn on web server	14
2.2.2	Log into web server.....	15
2.3	Administer user accounts.....	16
2.4	Create device web pages	18
2.5	Web server settings	22
2.5.1	Operating page settings "Time of day/date"	22
2.5.2	Operating page settings "Settings"	23
2.5.3	Operating page settings "Message recipient"	30
2.6	Commission network components	32
2.6.1	Operator station on a local area network (LAN)	32
2.6.2	Router	33
2.7	Functional check	34
2.8	Additional settings	36
2.9	Final steps	37
2.9.1	Check faults	37
2.9.2	Final steps on web server	37
2.10	Supply state	38
2.11	Update software	38
3	Operate using a web browser.....	39
3.1	Overview	39
3.2	Operate the plant	41
3.2.1	Bus device operation	41
3.2.2	Operate web server	41
3.2.3	Web server diagnostics.....	44
3.3	Faults	47
3.3.1	Overview	47
3.3.2	Web server fault.....	47
3.4	File transfer	48
3.5	Operation with ACS790.....	51

4	Visualize plants	53
4.1	Overview	53
4.2	Example of a plant web page.....	54
4.3	Plant web page features	55
4.4	Toolbar.....	56
4.5	Import web-capable plant diagrams.....	57
4.6	Create own plant web pages.....	59
5	"Energy indicator" function	63
5.1	Introduction.....	63
5.1.1	Function description	63
5.1.2	LPB/BSB bus topology.....	64
5.1.3	LPB/BSB devices	65
5.1.4	Navigation and device web pages	65
5.2	"Energy indicator" function levels.....	66
5.2.1	"Plant" level	66
5.2.2	"Partial plants" level.....	67
5.2.3	"Data points" level	68
5.2.4	Number of "Monitored data points"	69
5.2.5	"Energy indicator" visibility	70
5.2.6	Summary display "Energy indicator" for a plant.....	71
5.3	"Energy indicator" commissioning function	72
5.3.1	Commissioning notes.....	72
5.3.2	Start "Energy indicator" function.....	72
5.3.3	Estimated processing time	73
5.3.4	Deactivating "Data point monitoring".....	73
5.3.5	Activating "Data point monitoring"	75
5.4	Dialog boxes, data points, and "Green limits"	77
5.4.1	General dialog boxes	77
5.4.2	Dialog boxes with numeric data points.....	78
5.4.3	Dialog boxes with enumeration data points	79
5.4.4	User groups "Service" and "End user"	79
5.5	E-mail with "Energy indicator" for the plant.....	80
5.5.1	E-mail receiver configuration.....	80
5.5.2	Mail inbox	81
5.5.3	E-mail contents.....	82
5.6	Exceptions.....	83
6	Communications	85
6.1	Remote operation.....	85
6.1.1	Local area network (LAN)	85
6.1.2	Remote operation via the Internet.....	89
6.2	Messages via e-mail	93
7	Appendix	99
7.1	General notes.....	99
7.2	Diagnostics.....	99
7.2.1	Web server fault codes	99
7.2.2	Windows commander.....	100

7.3	Communications	101
7.3.1	Internet protocol	101
7.3.2	Free e-mail account providers	101
7.3.3	Install RNDIS driver.....	102
7.3.4	Alternative network configuration.....	103
7.3.5	Siemens routers.....	105
7.4	Glossary of Ethernet and Internet terms.....	106
Index	113

1 Overview

1.1 Introduction

Type summary

Product number	Max. number of monitored devices
OZW672.01	1 LPB or 1 BSB device
OZW672.04	4 LPBs or 1 BSB device(s)
OZW672.16	16 LPBs or 1 BSB device(s)

Document contents

The document describes commissioning and operating the web server OZW672. In this edition of "Web server OZW672, V4.0", the new "Energy indicator" function is described in Section 5. Sections 2 and 6 contain supplementary information on the DHCP client.

Focus on web browser operation

The ACS790 PC software can also be used to commission and operate the web server OZW672. To simplify reading, this document focuses on commissioning and operating via web browser.

Important notes



This symbol draws your attention to special safety notes and warnings. Ignoring this type of note may result in device damage and personal injury.

Safety / Product liability

- Devices may only be used in building technical plants and for the described applications only. Comply with all local regulation (installation, etc.).
- Disconnect the power and immediately replace a defective or obviously damaged device.
- Do not open the device. Failure to comply will invalidate any warranty claims.
- The technical data are provided solely for use with Siemens bus devices. The user ensures the functionality of operation when using third-party devices not expressly mentioned here. Siemens assumes **no** responsibility for service and warranty under these circumstances.

Intended use

Trouble-free and safe product operation presupposes transport, storage, mounting, installation, and commissioning as intended as well as careful operation.

Disposal



Dispose of the device as electronic waste in compliance with European directive 2002/96/EEC (WEEE) and not as municipal waste. Observe all corresponding national, legal regulations, and dispose of the device via appropriate channels. Comply with all locally applicable laws and regulations.

1.2 Display and operating elements

Overview

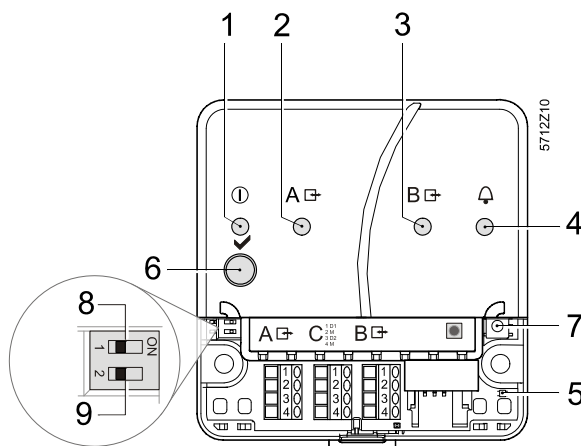

Pos	Name
1	On LED, Operation and "Energy indicator"
2	LPB/BSB LED
3	No function
4	Fault LED
5 (LED)	No function
6	Remote button
7	Service button
8	Message suppression switch
9	No function

LED displays

- 1 (red/ green/orange)
- Dark No power.
 - Steady red Web server starts operating system.
 - Flashing red Web server starts application.
 - Steady green Web server operational, "Energy indicator" = "Green leaf".
 - Steady orange Web server operational, "Energy indicator" = "Orange leaf".

- 2 LPB/BSB A (green)
- Dark No bus power.
 - Lit LPB/BSB operational.
 - Flashing Communication on LPB/BSB.

- 3 (LED) B No function.

- 4 Faults (red)
- Dark No fault (normal operating state).
 - Lit Fault exists.

- 5 (LED) No function.

Operating buttons

- 6 Remote
- Long (> 6 s) Sends system report to fault e-mail recipients (not to "Energy indicator" recipients)

- 7 Service
- Long (> 6 s) See "Button combinations".

Button combinations

- and
- Long (> 6 s) Simultaneously press and restores default factory settings.
Note : All configuration data and settings are reset. The device list, uploaded files, and all unsent messages are deleted. History data is not deleted.

Switch

- 8 Message inhibition
- Position "On" Messages cannot be sent.
 - Position "Off" Message sending allowed.

- 9 (DIP switches) No function.

1.3 Web operation

Use the web browser to operate the web server. The main window is sub-divided into various display areas.

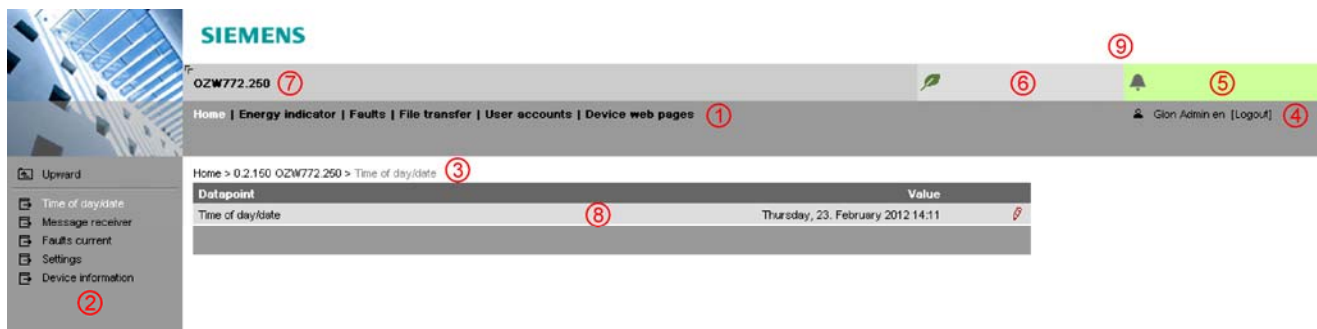

1 Primary navigation

The following main functions are selected via primary navigation:

Home	Menu-based plant and device operation.
Energy indicator	Display and operate "Energy indicator" data points.
Faults	Display system faults.
File transfer	Download of event history, upload of documents, logos and system definitions.
User accounts	User administration.
Device web pages	Create device list and operating pages.

2 Secondary navigation

Device operation (via home) queries devices and their operating pages via secondary navigation (menu tree).

3 Command sequence

The path displays the workflow starting at the main menu to the open operating page. Simply click at any point on the path to return to that location.

4 User

This field shows the currently logged-in user. Clicking [Logout] ends the current session. The session remains active until logout.

5 Plant state fault

The "Plant state fault" field is displayed permanently:

- Green field: No fault
- Red field: Plant fault

Click the "Plant state fault" field to display all faults in the plant.

6 Plant state Energy indicator

The "Plant state Energy indicator" field is displayed permanently:

- Green leaf: All "Energy indicator" data points are always within their "green limits", i.e. "within the green/allowed range".
- Orange leaf: One or multiple "Energy indicator" data points are outside their "green limits"

Clicking the "Plant state Energy indicator" field opens the "Energy indicator" function.

7 Plant name

Displays plant name as entered.

8 Display

The display range displays content corresponding to the selected function via primary and secondary navigation.

9 Logo area

Shows Logo 1 and Logo 2.

1.3.1 User levels

Display and operation depend on the access level of the logged in user:

End user

- Operate end user data.
- Fault overview
- Administer own user account.

The screenshot shows the Siemens web server interface for an end user. The user is logged in as 'Enduser'. The breadcrumb trail is 'Home > 0.1 RVSE1.843/109 > Heat circuit 1'. The main content area displays a table of datapoints for 'Heat circuit 1'.

Datapoint	Value
700 Operating mode heat circuit 1	Reduced
710 Room temperature Comfort setpoint HC1	21.0 °C
712 Room temp reduced setpoint heat circuit 1	19.0 °C
714 Room temp frost protection setpoint HC1	10.0 °C
720 Heating curve 1 slope	0.80
730 Summer/winter changeover temp heat circuit 1	18.0 °C

Service

- Operate service and end user data.
- Fault overview
- Documents, Message history, Logos, and System definitions.
- Administer own user account.

The screenshot shows the Siemens web server interface for a service user. The user is logged in as 'Service'. The breadcrumb trail is 'Home > 0.1 RVSE1.843/109 > Heat circuit 1'. The main content area displays a table of datapoints for 'Heat circuit 1'.

Datapoint	Value
700 Operating mode heat circuit 1	Reduced
710 Room temperature Comfort setpoint HC1	21.0 °C
712 Room temp reduced setpoint heat circuit 1	19.0 °C
714 Room temp frost protection setpoint HC1	10.0 °C
716 Comfort setpoint max heating circuit 1	35.0 °C
720 Heating curve 1 slope	---
721 Heating curve parallel displacement HC1	---
726 Heating curve adaptation heat circuit 1	---
730 Summer/winter changeover temp heat circuit 1	---

Administrator

- Operate service and end user data.
- Fault overview
- Documents, Message history, Logos and System definitions.
- Administer all user accounts.
- Create device websites.





























The screenshot shows the Siemens web server interface for an administrator user. The user is logged in as 'Administrator'. The breadcrumb trail is 'Home > 0.1 RVSE1.843/109 > Heat circuit 1'. The main content area displays a table of datapoints for 'Heat circuit 1'.

Datapoint	Value
700 Operating mode heat circuit 1	Reduced
710 Room temperature Comfort setpoint HC1	21.0 °C
712 Room temp reduced setpoint heat circuit 1	19.0 °C
714 Room temp frost protection setpoint HC1	10.0 °C
716 Comfort setpoint max heating circuit 1	35.0 °C
720 Heating curve 1 slope	0.80
721 Heating curve parallel displacement HC1	0.0 °C
726 Heating curve adaptation heat circuit 1	Off
730 Summer/winter changeover temp heat circuit 1	18.0 °C

1.4 Symbols, notations, abbreviations

1.4.1 Symbols

Symbols

Symbol	Meaning
	Data point at the service level.
	Data point at the end user level.
	Read/write data point; the setting value can be changed.
	Read-only data point; the value cannot be changed.
	Link to entry field.
	Delete object.
	Checkbox.
	Selection box.
	Calendar.
	Arrows to incrementally adjust values.
	Adjustment tab.
	Arrow to display sort order.
	Up.
	File upload (to web server).
	File download (from web server).
	Safety note, intended to protect against misuse.
	Always observe/follow.
	Note; important information.
	Network connection.
	Link to device.
	User.
	Message history.
	System definitions
	Logos.
	Switch over displays: Full view, partial view
	Fault indication: Green field = no fault; red field = fault (alarm)
	"Green leaf"
	"Orange leaf"
	"Grey leaf"

1.4.2 Notations

Command sequences

Menu command sequences are printed as follows:

- Web server: Home > 0.5 OZW672... > Settings > Time of day/date
- PC: *Start > Settings > Network connections > Local Area Connection*
OZW672... stands for: OZW672.01 or
OZW672.04 or
OZW672.16

IP address, domains

Entry in the web browser address line:

- IP address: 192.168.2.10
- Domains: www.siemens.com

Buttons

Buttons are written as follows: [Add]

1.4.3 Abbreviations

Abbreviations

Auto MDI-X	Auto Medium Dependent Interface - Crossed
DHCP	Dynamic Host Configuration Protocol
DynDNS	Dynamic Domain Name System
HTTP	Hyper Text Transfer Protocol
HTTPS	Hyper Text Transfer Protocol Secure
IP	Internet Protocol
LPB	Local Process Bus
BSB	Boiler System Bus
NAT	Network Address Translation
PAT	Port and Address Translation
RNDIS	Remote Network Driver Interface Specification
SMTP	Simple Mail Transfer Protocol
STP	Shielded Twisted Pair
TCP	Transmission Control Protocol
TLS	Transport Layer Security
UPnP	Universal Plug and Play
USB	Universal Serial Bus
UTP	Unshielded Twisted Pair
Web API	Web Application Programming Interface

Further explanations on abbreviations and terms are available in the appendix.

2 Commissioning

This section describes how to commission the web server.



2.1 Prerequisites

Prerequisites

The following conditions must be met to commission the web server:

- The web server is mounted and wired (see Installation instructions, G5711).
- The connected bus device is commissioned.
- The bus device has a valid address and is operational.
- The bus device works trouble free; the fault LED  is not lit.
- The bus power supply to the bus device is turned on.
- Recommended by clock time supplier: The LPB bus device is clock slave with remote setting.
- Connecting a SmartPhone App to a web server makes sense only after the web server is fully commissioned.

Notes



-  IP address USB: 192.168.250.1 (cannot be changed)
IP address Ethernet: As per the address assigned by the router.
Without router: 192.168.2.10 (default state, see Section 6.1.1)
- Commissioning with a PC/laptop and a web browser via the USB interface. The RNDIS driver must be installed to connect via USB.
- The RNDIS driver is automatically installed when connecting via USB if the PC/laptop is connected to the Internet (as long as the Microsoft online update is enabled). You can manually install the RNDIS driver when there is no connection to the Internet (see Section 7.3.3).
- The RNDIS driver is supplied on the web server at <http://<IP-Adresse>/drivers/>.
- To navigate, always start with primary navigation, then use the secondary navigation to select the desired menu item.
- Return: Click  "Upward" or navigate via the path or primary navigation.

2.2 Getting started

2.2.1 Turn on web server

Turn on web server

Connect the web server to the power supply and connect it to the PC:

1. Connect power supply to turn on power on web server. The web server is operational, when the green **I** LED is lit.
2. Check additional displays:
 - LED **A**  Green light if LPB/BSB bus power supply is available. Check the LPB/BSB bus wiring and setting for the bus power supply on the bus device if no bus power supply is available.
 - LED  Dark if no fault is pending. You can resolve pending faults later (see Section 2.9).
3. Plug the supplied USB cable into the web server and the PC and start up the PC. The PX recognizes the web server as a USB device. Otherwise, the RNDIS is still not installed.

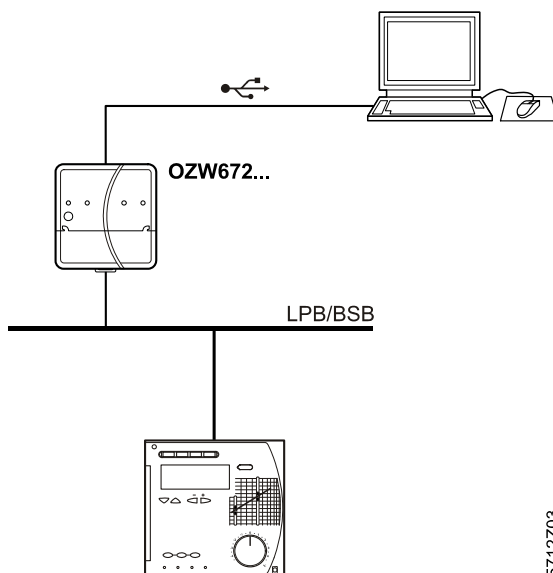

4. The RNDIS driver is installed automatically if the PC is connected to the Internet and no RNDIS driver is installed. The installation wizard will guide you through installation.

Note

 You can also manually set up the RNDIS driver (see Section 7.3.3).

2.2.2 Log into web server

Log on

A PC with USB interface and web browser is used to commission the web server.

1. Start web browser.
2. In the address line, enter the USB IP address (192.168.250.1).

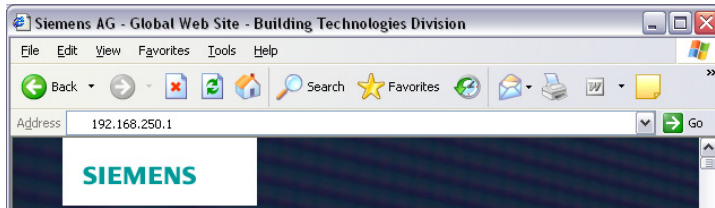

3. First time Login
 - User name *Administrator*
 - Password *Password*

Login	
User name	<input type="text" value="Administrator"/>
Password	<input type="password" value="Password"/>
<input type="button" value="Login"/>	

4. Click [Login] to finish.
5. After logging on the first time, the dialog box is displayed to define a new password.

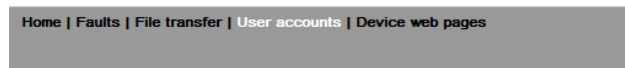

Change user	
User name	<input type="text" value="Administrator"/>
Password	<input type="password"/>
Repeat password	<input type="password"/>
Description (optional)	<input type="text"/>
E-mail address (optional)	<input type="text"/>
Language	<input type="text" value="English"/>
<input type="button" value="OK"/>	

Important note



- **A new password must** be defined the first time you log in (you can also change the language).
- You cannot exit the dialog box if you do not define a new password (i.e. not equal to "Password") and the following note is displayed:



- The following message is displayed if you fail to fill out all required fields:

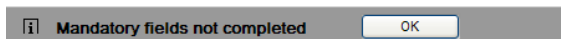

- Capitalization must be observed when entering the password.

2.3 Administer user accounts

Administer user accounts

Use the "User accounts" menu to change the administrator password at delivery and set up additional user accounts.

Note



The user account settings equally apply to access via Smartphone app and other applications via Web API.

User name	Description (optional)	E-mail address (optional)	Language	User group
Administrator			English	Administrator

Change administrator data

Procedure:

1. Click red pencil symbol

The "Change user" dialog box opens.

Change user	
User name	Administrator
Password
Repeat password
Description (optional)	John Sample
E-mail address (optional)	john.sample@siemens.com
Language	English
<input type="button" value="OK"/> <input type="button" value="Cancel"/>	

2. Change administrator data:
 - Password
 - Repeat Password
 - Description (optional)
 - Email address (optional)
 - Language: English
3. Click [OK] to finish.

Add a new user

Procedure:

1. Click [Add]
The "Add user" dialog box is displayed.

Add user	
User name	John Keeper
Password
Repeat password
Description (optional)	Housekeeper
E-mail address (optional)	housekeeper@siemens.com
Language	English
User group	Enduser
<input type="button" value="OK"/> <input type="button" value="Cancel"/>	

2. Enter / select user data:
 - User name
 - Password
 - Repeat password
 - Description (optional)
 - E-mail address (optional)
 - Language: English
 - User group
3. Close with [OK]

Change user data

Procedure:

1. Click red pencil symbol  for the corresponding user.
The "Change user" dialog box opens.

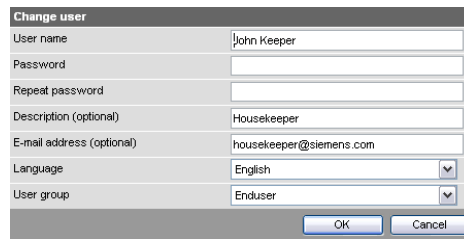

2. Change user data:
 - User name
 - Password
 - Repeat password
 - Description (optional)
 - E-mail address (optional)
 - Language: English
3. User group. Close with [OK]

Delete user account

Procedure:

1. Click red garbage can  for the corresponding user.
The "User accounts" dialog box is displayed.



2. Click [Yes] for "User to be deleted?".

Notes

-  • The administrator account cannot be deleted. The name "Administrator" and user group "Administrator" cannot be changed. You may, however, add user accounts with administrator rights.
- You can only add new users and delete existing ones on the "Administrator" user level.
- Changing other user accounts is reserved to the "Administrator" user level.
- A secure password is comprised of lowercase and uppercase letters, numbers and special characters, is at least 20 characters long, and does not include a name or words from dictionaries.

2.4 Create device web pages

Create device websites

You must first add associated devices and device websites before you can operate the web server and the bus device. To this via the "Device web pages" menu.

Note

 Device web pages can only be created on the "Administrator" user level.

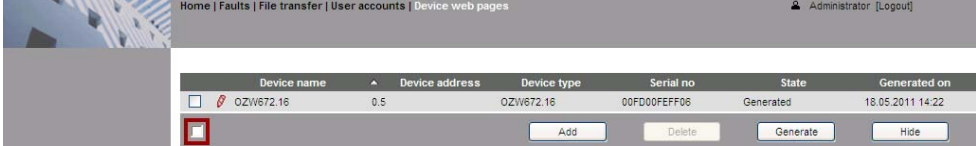

Device name	Device address	Device type	Serial no	State	Generated on
<input type="checkbox"/> OZW672.16	0.5	OZW672.16	00FD00FEFFD6	Generated	18.05.2011 14:22

Linked devices are listed in a table with the following information:

- Device name
- Device address Device type
- Serial number
- State
- Generated on

Notes

- 
- Click the column header to sort the table.
 - Per default, the devices are sorted in ascending device address order.
 - The web server itself is already in the device list.
 - Only added bus devices are monitored.
 - Only generated bus devices can be operated.
 - Changes to settings of the connected bus device may require that the device web pages be recreated or updated to apply changes from web operation.
 - You must delete and re-add a bus device after you update the bus device software, or replace the bus device.

Add device

Note

 You can only add a device on the "Administrator" user level.

The workflow below shows how to add a bus device and create the associated device web page(s):

1. Click [Add]
2. Enter the bus address:
LPB: Segment number and Device number.

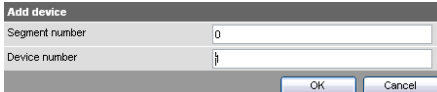



3. BSB: Device number (default: 1=basic device).



4. You can add just one BSB device to the device list.
5. Click [OK] to confirm.

The web server searches for a device with the entered **bus address**. It is displayed in the device list if found.



- The added device can be named by clicking the red pencil symbol for the corresponding device . A maximum of 20 characters are available.
- Select the devices whose web pages you want to create.

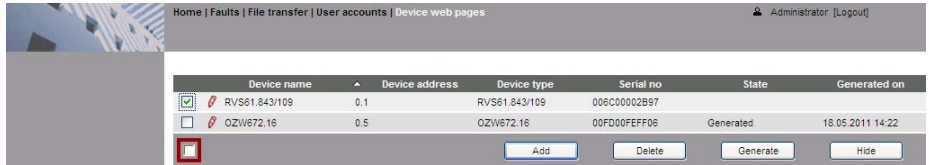

- Click [Generate]
Device web pages are generated.
Process takes a few minutes

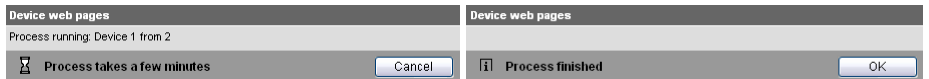

- Wait until  **Process finished** is displayed.
In the device list, the web server and the bus device display state "Generated".

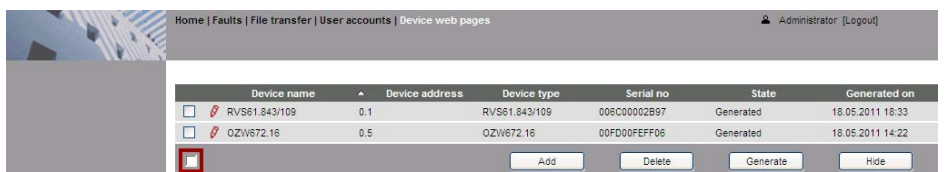

- The device websites are now available under **Home**.

Delete device

Note

-  You can only delete a bus device on the "Administrator" user level.

Procedure:

- Select the bus device you want to remove from the device list .

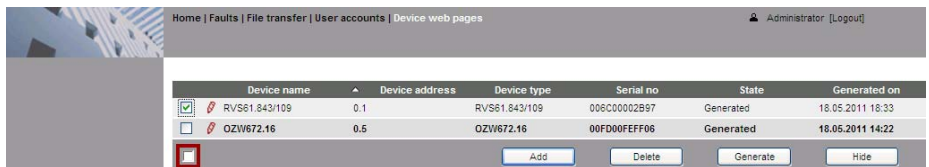

- Click [Delete]
- Click [Yes] to confirm.



The web server removes the device from the device list.

- Wait until  **Process finished** is displayed.



- Click [OK] confirm.
The device is removed from the device list.

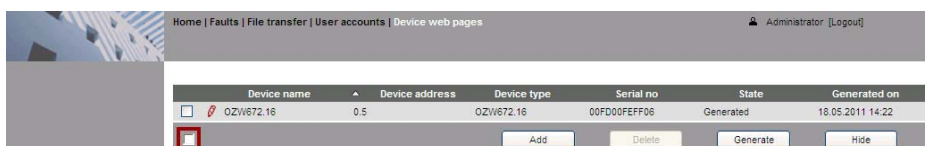

Create device web pages

You must create device web pages for the following cases:

- After you add a device (see "Add device").
- Changes to settings of the connected bus device may require that the device web pages be recreated to apply changes from web operation.
- For changes to be applied, you must recreate the device web pages after you update the system definition (see Section 3.4, part "Upload system definitions").

Note

 Device web pages can only be created on the "Administrator" user level.

Procedure

1. Select  the devices whose web pages you want to newly create.

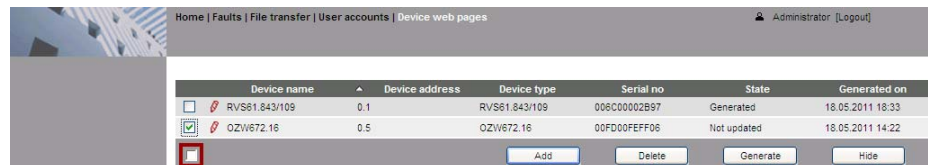

2. Click [Generate]
Device web pages are generated.

Process takes a few minutes



3. Wait until  **Process finished** is displayed.
4. Close with [OK]
In the device list, the web server and the bus device display state "Generated".

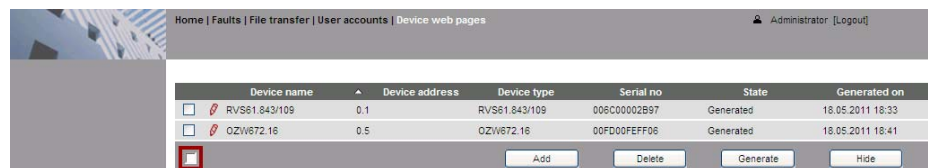

Update device websites

When you change one of the following texts, the status at the web server changes from "Generated" to "Not updated":

- Message receiver 1...4
- Fault input 1...2
- Text for: No fault
- Text for: Fault

You can change the following texts without influencing device status:

- Name (web server).
- Bus device name.

You must update the device web pages of the web server to apply all text changes to the menu.

Notes

-  You can update device web pages on user levels "Administrator" and "Service".
- Click [Update] on the Service and [Generate] on the Administrator level to start updating (see "Create device web pages").

The following update procedure applies to the Service level:

1. Select the web server .

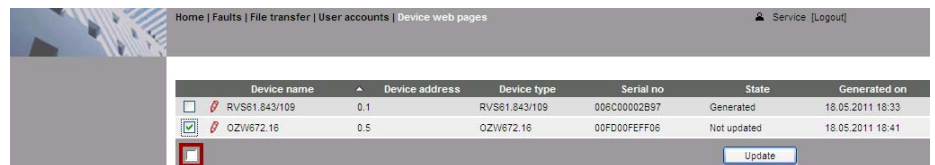

2. Click [Update]
The device web pages are updated.

Process takes a few minutes



3. Wait until  **Process finished** is displayed.
The device list for the web server display state "Generated".



2.5 Web server settings

The "Home" menu is used to set the web server. The web server and then the corresponding operating page are selected in secondary navigation.

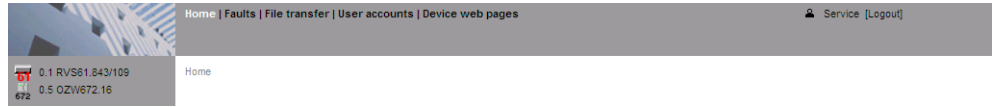

Notes



- The settings depend on the user level.
- This section does not describe read-only data points.

2.5.1 Operating page settings "Time of day/date"

Time of day/date

Path: Home > 0.5 OZW672... > Time of day/date

Backup battery



The clock has a backup battery for at least 72 hours. The clock continues to run after power failure for the duration of the backup battery.

Both date and time are reset in case of an extended interruption.

- The time is corrected automatically if the time is synchronized to the master clock on the LPB/BSB bus (see Section 2.5.2, LPB / BSB).
- Otherwise, both date and time must be newly set.

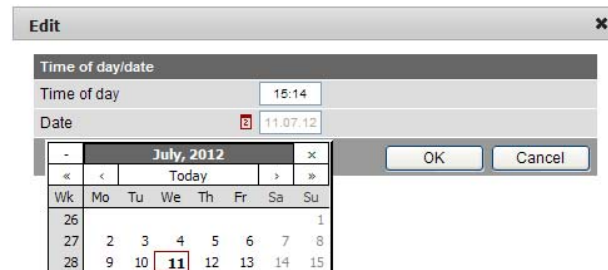
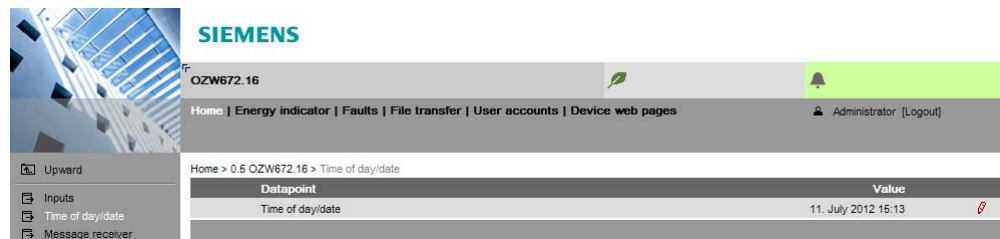

Data point	Explanation, example		
Time of day/date Default val: 00:00 1.1.2005 Setting val: Time of day/date	Set the current time and date. Weekday is calculated automatically.		



2.5.2 Operating page settings "Settings"

Language

Path: Home > 0.5 OZW672... > Settings > Web server



Data point	Explanation, example		
Language Default val: English Setting val: See example	Web server language. The language set is applied to web server fault text messages, message history, messages and system reports.	<input checked="" type="radio"/>	<input type="radio"/>
Code Default val: 01 Setting val: max. 20 char.	Access code for PC Software ACS790.	<input checked="" type="radio"/>	<input type="radio"/>
Reset admin password * Default val: No Setting val: Yes	If you do not know the administrator password for the web server, setting value "Yes" again provides access to the web server via the administrator password "Password" ("Password" = Factory setting for administrator password). Setting value "Yes" is a temporary state, i.e. the setting value automatically goes to "No" after ca. 2 seconds.	<input type="radio"/>	<input checked="" type="radio"/>

* with PC software ACS790 only.

Time of day/date

Path: Home > 0.5 OZW672... > Settings > Time of day/date



Changeover to daylight saving time and back is automatic. The dates are set internationally and can be changed if the international standard is changed.

Data point	Explanation, example		
Summer time start Default val.: 25. March Setting val.: 01.01...31.12.	Date for changeover to daylight saving time: On the first Sunday from this point, one hour is added to current time (standard time), i.e. time is adjusted forward one hour.	<input checked="" type="radio"/>	<input type="radio"/>
Winter time start Default val.: 25. October Setting val.: 01.01...31.12.	Date for changeover to standard time: On the first Sunday from this point, one hour is deducted from current time (daylight saving time), i.e. time is adjusted backward one hour.	<input checked="" type="radio"/>	<input type="radio"/>

Note



Disable the function by setting both start of daylight saving and standard time to the same date.

Data point	Explanation, example		
Device number* Default val: 5 Setting val: 5...8	Set the Device number. The device number (segment and device number) must be unique within the same LPB bus system. The setting is meaningless on the BSB: The BSB device address of the web server is canned (50).	<input checked="" type="radio"/>	<input type="radio"/>
Clock time source* Default val: Autonomous Setting val: Autonomous, Slave with remote setting, Slave without rem setting, Master	Autonomous: Time/date is created from the Quartz of the web server. No synchronization with bus devices. Slave with remote setting: Web server receives time/date from master. The master supplies both date and time on the web server and is then sent to all bus devices. Slave without rem setting: Web server receives time/date from master. The web server date/time setting is not sent to the master. The master resets date/time. Master: Time/date is created from the Quartz of the web server. The web server supplies both date and time to all bus devices. Recommended: Configure web server as master and bus device as slave with or without remote setting.	<input checked="" type="radio"/>	<input type="radio"/>



* This setting affects the LPB only.
 The Device number and time supplier are automatically specified on BSB.

Ethernet

Notes



- Enter these settings if you intend to operate the web server on a local area network (LAN) or via the Internet.
- For more information on different network topologies, see Section 6.

Data point	Explanation, example		
DHCP client Default val: On Setting val: Off, On	Service automatically getting the web server's IP network configuration automatically from the router; see Section 6.1.1.	<input checked="" type="radio"/>	<input type="radio"/>
IP address Default val: 192.168.2.10 Setting val: IP address	Web server IP address. Does not require setting if "DHCP client = On".	<input checked="" type="radio"/>	<input type="radio"/>
Subnet mask Default val: 255.255.255.0 Setting val: IP address	The IP subnet mask sets the size of the subnet. Does not require setting if "DHCP client = On".	<input checked="" type="radio"/>	<input type="radio"/>
Default gateway Default val: 192.168.2.1 Setting val: IP address	The standard gateway represents the interface between the local and public network. You typically enter the IP address for the router here. Does not require setting if "DHCP client = On".	<input checked="" type="radio"/>	<input type="radio"/>

Preferred DNS server Default val: 192.168.2.1 Setting val: IP address	The DNS server (domain name system) on the Internet connects a globally valid name to a domain with an IP address (e.g. domain www.siemens.com with IP address 146.254.191.150). The setting corresponds to the IP address for the next router or DNS server that recognizes for its part a queried name (domain) or another DNS server. The setting is typically identical to the setting for the standard Gateway. Required to send e-mails. Does not require setting if "DHCP client = On".	●	—
Alternate DNS server Default val: (blank) Setting val: IP address	The alternative DNS server is only defined for redundant systems. Settings are typically empty. Does not require setting if "DHCP client = On".	●	—
UPnP localization Default val: Ethernet Setting val: ---, Ethernet, USB	The web server registers its presence in the network via the Universal Plug and Play (UPnP) service.	●	—

UPnP localization



Web server registers its existence via Ethernet, when

- "UPnP localization" = "Ethernet" is set *and*
- The connection between PC/laptop and the web server is active via Ethernet.

The screenshot shows the Siemens OZW672.16 web interface. The breadcrumb trail is: Home > 0.5 OZW672.16 > Settings > Communication > Ethernet. The main content area displays a table of network settings:

Datapoint	Value
DHCP client	On
IP address	192.168.2.10
Subnet mask	255.255.255.0
Default gateway	
Preferred DNS server	
Alternate DNS server	
Set when DHCP client off	
IP address	192.168.2.10
Subnet mask	255.255.255.0
Default gateway	192.168.2.1
Preferred DNS server	192.168.2.1
Alternate DNS server	
UPnP localization	Ethernet
Physical address	00:a0:03:fd:25:5c

E-mail

Path: Home > 0.5 OZW672... > > Settings > Communication > E-mail

Notes



- Enter these settings if the web server is to send an e-mail for a fault.
- Additional information on email settings is available in Section 6.2.
- Automatically negotiate the securest connection:
TLS mode is selected automatically if the device sending the email and the email provider supports it.

Data point	Explanation, example		
Address mail server Default val: smtp.example.com Setting val: Max. 46 characters	The provider supplies the IP address or mail server domain name. Often referred to as the outgoing mail server or SMTP server instead of mail server.	<input checked="" type="radio"/>	<input type="radio"/>
Port number mail server Default val: 25 Setting val: 1...65535	Port number 25 is default for the mail server (and does not normally require change).	<input checked="" type="radio"/>	<input type="radio"/>
E-mail address sender Default val: OZW672@example.com Setting value: Max. 46 characters	The setting corresponds to the e-mail address of the web server. The email address is displayed in the "From" field of each email.	<input checked="" type="radio"/>	<input type="radio"/>
Authentication mail server Default val: No Setting val: No/Yes	Select Yes for mail server access with authentication. In this case, user name and password (data points below) are required.	<input checked="" type="radio"/>	<input type="radio"/>
User name Default val: (Blank) Setting val: Max. 46 char.	User name and password help authenticate each e-mail via the mail server.	<input checked="" type="radio"/>	<input type="radio"/>
Password Default val: (Blank) Setting val: Max. 46 char.	Password and user name help authenticate each email via the mail server.	<input checked="" type="radio"/>	<input type="radio"/>
Signature line 1..10 Default val: (Blank) Setting val: Max. 46 char.	Signature lines are transmitted with the e-mail. It identifies the sender, e.g. the plant's Internet address.	<input checked="" type="radio"/>	<input type="radio"/>

USB

Path: Home > 0.5 OZW672... > Settings > Communication > USB

Data point	Explanation, example		
UPnP localization Default val: USB Setting val: ---, Ethernet, USB	The web server registers its presence in the network via the Universal Plug and Play (UPnP) service.	<input checked="" type="radio"/>	<input type="radio"/>

UPnP localization



Web server registers its existence in the USB network, when

- "UPnP localization" = "USB" is set *and*
- The connection between PC/laptop and the web server is active via USB.

Message receiver 1...4

Path: Home > 0.5 OZW672... > Settings > Message receiver > Message receiver 1...4

Note



The settings are made if the web server sends messages via e-mail.

Data point	Explanation, example		
Message receiver 1...4 Default val: (Blank) Setting val: Max. 20 char.	Customizable text for message recipient. The designation is displayed in the menu and transmitted as part of the message. Notes: <ul style="list-style-type: none">Note Section 2.4 "Update device web pages".Delete the entry to reset to default text.	<input checked="" type="radio"/>	<input type="radio"/>
Receiver type Default val: --- Setting val: ---, E-mail	The following recipient types are available: ---: No messages to this recipient. E-mail: Message recipient configured for e-mail messages via Ethernet.	<input checked="" type="radio"/>	<input type="radio"/>
Fault priority Default val: All Setting val: All, Only urgent ones	Setting value " Only urgent ones " serves as a filter when sending system reports and fault status messages.	<input checked="" type="radio"/>	<input type="radio"/>
E-mail address Default val: messagereceiver@ example.com Setting val: Max. 46 characters	For E-mail recipient types: Setting value is recipient email address.	<input checked="" type="radio"/>	<input type="radio"/>

System report

Path: Home > 0.5 OZW672... > Settings > System report

Note



Enter these settings if the web server is to regularly send an e-mail for a fault.

Data point	Explanation, example		
Signal time Default val: 06:00 hh:mm Setting val: 00:00...23:59 (Resol. 00:01).	The setting value corresponds to the time of day when a system report is sent (time can be defined).	<input checked="" type="radio"/>	<input type="radio"/>
Message cycle Default val: 1 d (day) Setting val: 0...255 d (Resolution: 1 d)	The setting value corresponds to the interval (in days) at which a system report is sent. The first system report is delivered after completion of the first message cycle and then as per the message cycle. The system report is disabled when the message cycle =0.	<input checked="" type="radio"/>	<input type="radio"/>
Priority Default val: Urgent Setting val: Urgent / Not urgent	Filter when sending the system reports. The setting " Urgent " sends the system report to all active message recipients. The setting Not urgent exempts all message recipients subscribing to "Only urgent ones".	<input checked="" type="radio"/>	<input type="radio"/>
Next report Default val: 0 d (day) Setting val: 0...255 d (Resolution: 1 d)	Waiting time to next system report.	<input checked="" type="radio"/>	<input type="radio"/>

Fault input 1...2

Path: Home > 0.5 OZW672... > Settings > Inputs > Fault input 1...2

Note



Digital inputs D1, D2 help connect potential-free status contacts. They work as fault inputs.

The following settings show how to configure fault inputs.

Select "Settings > Faults > Local > Fault input 1...2" to define behavior during faults.

Data point	Explanation, example		
Fault input 1...2* Default val: (Blank) Setting val: Max. 20 char.	Customizable text for fault input. The designation is displayed in the menu and transmitted as part of the message. Identical to data point in "Settings > Faults > Local > Fault input 1...2".	<input checked="" type="radio"/>	<input type="radio"/>
Normal position Default val: Open Setting val: Open, Closed	Normal position specifies the contact position deemed "No fault".	<input checked="" type="radio"/>	<input type="radio"/>
Text for: Logic 0* Default val: 0 Setting val: Max. 20 characters	Logic 0: No fault. Customizable text for fault input status, e.g. Water pressure normal.	<input checked="" type="radio"/>	<input type="radio"/>
Text for: Logic 1* Default val: 1 Setting val: Max. 20 char.	Logic 1: Fault. Customizable text for fault input status, e.g. Water pressure too low.	<input checked="" type="radio"/>	<input type="radio"/>

* Notes:

- Note Section 2.4, "Update device web pages".
- Delete the entry to reset to default text.

Faults

Path: Home > 0.5 OZW672... > Settings > Faults

The following settings specify behavior in case of faults.

Select "Settings > Inputs > Fault input 1...2" to configure the fault inputs.

Data point	Explanation, example		
Message triggering Default val.: Coming Setting val: Coming, Coming and going	Coming: A message is triggered when a fault is received (start of fault). Coming and going: A corresponding message is triggered at start and end of fault. A web server fault displays the LED	<input checked="" type="radio"/>	<input type="radio"/>
Fault input 1..2* Default val.: (Blank) Setting val: Max. 20 char.	Customizable text for fault input. The designation is displayed in the menu and transmitted as part of the message. Identical to data point in "Settings > Inputs > Fault input 1...2".	<input checked="" type="radio"/>	<input type="radio"/>
Fault status message delay mm:ss Default val.: 00:05. Setting val: 00:00...59:55 (Resolution 00:05)	The Fault status message delay acts as a filter for short-term fault events. The time the web server must wait until a fault becomes active is set here.	<input checked="" type="radio"/>	<input type="radio"/>

Fault priority Default val.: Urgent Setting val.: Urgent Not urgent	Filter when sending a fault. The setting Urgent sends the fault to all active message recipients. The setting Not urgent exempts all message recipients subscribing to "Only urgent ones".	●	—
Text for: No fault* Default val: [Fault input x] Fault. Setting val: Max. 20 char.	Customizable text for the message for an outgoing fault at the fault input; e.g. Water pressure ok. The designation is transmitted in messages.	●	—
Text for: Fault* Default val: [Fault input x] Fault Setting val: Max. 20 char.	Customizable text for the message for an incoming fault at the fault input; e.g. Fill in water. The designation is transmitted in messages.	●	—

* Notes:



- Note Section 2.4, "Update device web pages".
- Delete the entry to reset to default text.

Note

 "System" faults refer to bus device faults received via LPB/BSB bus.

Texts

Path: Home > 0.5 OZW672... > Settings > Texts

Data point	Explanation, example		
Name Default val: OZW672.01 OZW672.04 OZW672.16 Setting val: max. 20 characters	User definable text for the plant displayed by web server and transmitted in the message. Update note on menu texts => Update or regenerate web server device web page.	●	—

2.5.3 Operating page settings "Message recipient"

Message receiver

You can define time periods for each message recipient when messages can be sent.

Notes



- The following settings are optional if you want to limit the time periods when messages can be sent (default: no time limit).
- General: Messages outside sending periods are resubmitted if they are still pending during the sending period.

Send messages

Path: Home > 0.5 OZW672... > Message receiver > Message receiver 1...4 > Send messages

You can define time periods per weekday or special day when messages can be sent to the message recipients.

Special days are defined via **Holidays/special days**.

Data point	Explanation, example		
Monday...Sunday, Special day Default val: Monday 00:00 On ... Special day 00:00 On ... Setting val: Monday...Sunday, Special day 00:00...24:00 Off / On	Max 3 sending periods can be defined when web servers can send messages for each weekday and special day(s). The previous day's status is transferred to the current day. The default settings is to always send messages.		

Monday	Tuesday	Wednesday
<input checked="" type="checkbox"/> 00:00 On	<input checked="" type="checkbox"/> 00:00 On	<input checked="" type="checkbox"/> 00:00 On
<input checked="" type="checkbox"/> 02:00 Off	<input checked="" type="checkbox"/> 02:00 Off	<input checked="" type="checkbox"/> 02:00 Off
<input checked="" type="checkbox"/> 04:00 On	<input checked="" type="checkbox"/> 04:00 On	<input checked="" type="checkbox"/> 04:00 On
<input checked="" type="checkbox"/> 06:00 Off	<input checked="" type="checkbox"/> 06:00 Off	<input checked="" type="checkbox"/> 06:00 Off
<input checked="" type="checkbox"/> 08:00 On	<input checked="" type="checkbox"/> 08:00 On	<input checked="" type="checkbox"/> 08:00 On
<input checked="" type="checkbox"/> 10:00 Off	<input checked="" type="checkbox"/> 10:00 Off	<input checked="" type="checkbox"/> 10:00 Off

Thursday	Friday	Saturday
<input checked="" type="checkbox"/> 00:00 On	<input checked="" type="checkbox"/> 00:00 On	<input checked="" type="checkbox"/> 00:00 On
<input checked="" type="checkbox"/> 02:00 Off	<input checked="" type="checkbox"/> 02:00 Off	<input checked="" type="checkbox"/> 02:00 Off
<input checked="" type="checkbox"/> 04:00 On	<input checked="" type="checkbox"/> 04:00 On	<input checked="" type="checkbox"/> 04:00 On
<input checked="" type="checkbox"/> 06:00 Off	<input checked="" type="checkbox"/> 06:00 Off	<input checked="" type="checkbox"/> 06:00 Off
<input checked="" type="checkbox"/> 08:00 On	<input checked="" type="checkbox"/> 08:00 On	<input checked="" type="checkbox"/> 08:00 On
<input checked="" type="checkbox"/> 10:00 Off	<input checked="" type="checkbox"/> 10:00 Off	<input checked="" type="checkbox"/> 10:00 Off

Sunday	Special day	Copy
<input checked="" type="checkbox"/> 00:00 On	<input checked="" type="checkbox"/> 00:00 On	From: Monday
<input checked="" type="checkbox"/> 02:00 Off	<input type="checkbox"/> 00:00 Off	To: <input type="checkbox"/> Monday <input type="checkbox"/> Tuesday
<input checked="" type="checkbox"/> 04:00 On	<input type="checkbox"/> 00:00 Off	<input type="checkbox"/> Wednesday <input type="checkbox"/> Thursday
<input checked="" type="checkbox"/> 06:00 Off	<input type="checkbox"/> 00:00 Off	<input type="checkbox"/> Friday <input type="checkbox"/> Saturday
<input checked="" type="checkbox"/> 08:00 On	<input type="checkbox"/> 00:00 Off	<input type="checkbox"/> Sunday <input type="checkbox"/> Special day
<input checked="" type="checkbox"/> 10:00 Off	<input type="checkbox"/> 00:00 Off	<input type="button" value="Copy"/>

Notes



- Check to enable switching points.
- You can copy the switching times for a day of the week by clicking [Copy] one day to a selection of other days .
- Click [Check] to check the data before it is saved.





Holidays/special days









Path: Home > 0.5 OZW672... Message receiver > Message receiver 1...4 > Holidays/special days

No messages are sent during vacation/holidays. For special days, sending periods are defined via "Send messages".

Notes

- General: Messages outside sending periods are resent during the next send period.
- If a special day occurs during a holiday/vacation, the day is a special day.
- Holidays/special days can be set as recurring days each year.

Data point	Explanation, example		
Entry 1...16 Default val: --- Setting val: Beginning End Reason Annually	Each recipient has a yearly calendar to enter holidays and special days. Holiday or special day can be selected as Reason . Beginning and End of the periods can be indicated with date and time. Selecting Annually repeats the periods each year.		

	<input type="checkbox"/>	<input type="checkbox"/>	Beginning	End	Reason	Annually
1	<input checked="" type="checkbox"/>		14.07.09	00:00	29.07.09 23:59	Holidays <input type="checkbox"/>
2	<input checked="" type="checkbox"/>		24.12.**	00:00	02.01.** 23:59	Holidays <input checked="" type="checkbox"/>
3	<input checked="" type="checkbox"/>		01.08.**	00:00	01.08.** 23:59	Special day <input checked="" type="checkbox"/>
4	<input type="checkbox"/>		01.01.00	00:00	01.01.00 23:59	Holidays <input type="checkbox"/>
5	<input type="checkbox"/>		01.01.00	00:00	01.01.00 23:59	Holidays <input type="checkbox"/>
6	<input type="checkbox"/>		01.01.00	00:00	01.01.00 23:59	Holidays <input type="checkbox"/>
7	<input type="checkbox"/>		01.01.00	00:00	01.01.00 23:59	Holidays <input type="checkbox"/>
8	<input type="checkbox"/>		01.01.00	00:00	01.01.00 23:59	Holidays <input type="checkbox"/>
9	<input type="checkbox"/>		01.01.00	00:00	01.01.00 23:59	Holidays <input type="checkbox"/>
10	<input type="checkbox"/>		01.01.00	00:00	01.01.00 23:59	Holidays <input type="checkbox"/>
11	<input type="checkbox"/>		01.01.00	00:00	01.01.00 23:59	Holidays <input type="checkbox"/>
12	<input type="checkbox"/>		01.01.00	00:00	01.01.00 23:59	Holidays <input type="checkbox"/>
13	<input type="checkbox"/>		01.01.00	00:00	01.01.00 23:59	Holidays <input type="checkbox"/>
14	<input type="checkbox"/>		01.01.00	00:00	01.01.00 23:59	Holidays <input type="checkbox"/>
15	<input type="checkbox"/>		01.01.00	00:00	01.01.00 23:59	Holidays <input type="checkbox"/>
16	<input type="checkbox"/>		01.01.00	00:00	01.01.00 23:59	Holidays <input type="checkbox"/>

Notes

- Select checkbox to select active entries.
- Select "Annually" to set annually recurring switching times.
- Click [Check] to check the data before it is saved.

2.6 Commission network components

Commissioning

The web server can be operated from a PC with web browser on a local area network (LAN) or via the Internet.

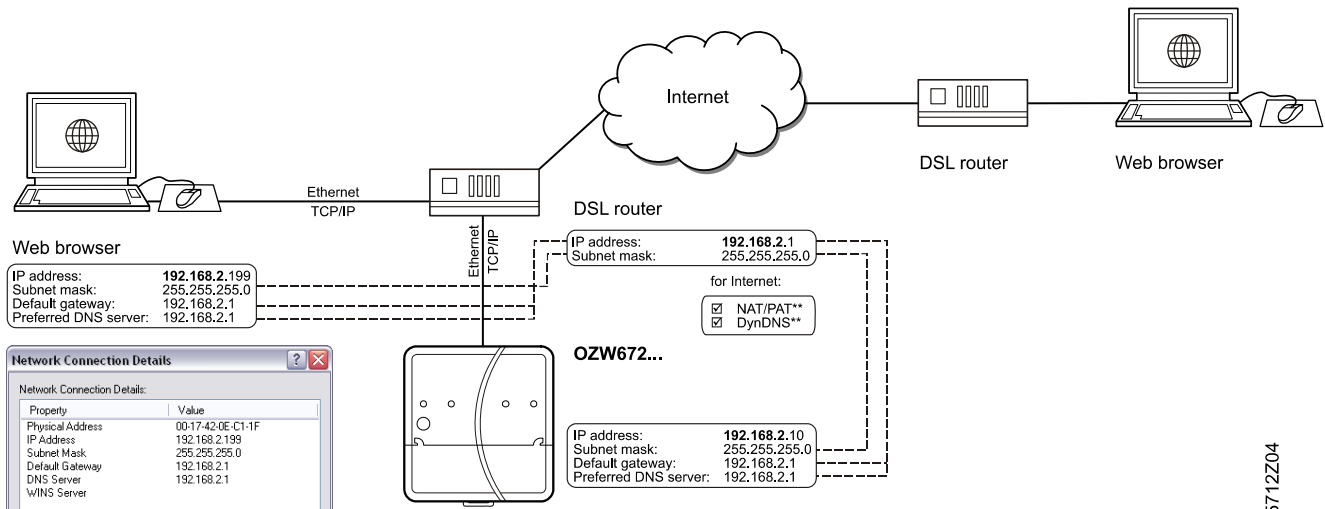

The illustration shows a typical application with operation via Internet and home network. The configuration data for the devices (IP address, Subnet mask, Default gateway und Preferred DNS server) are examples and show the various relationships (dotted lines).

2.6.1 Operator station on a local area network (LAN)

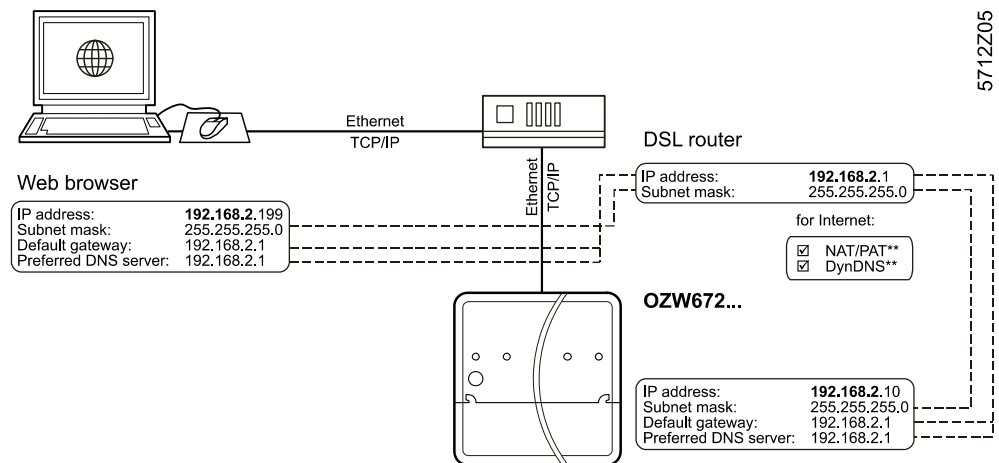

Operator station

The operator station requires the following settings, if the web server is operated from a PC with web browser on a local area network (LAN):

- IP address
- Subnet mask

Note

The addresses in the illustration are examples must be adapted to router addressing. See Section 6.1.1 for more details.

2.6.2 Router

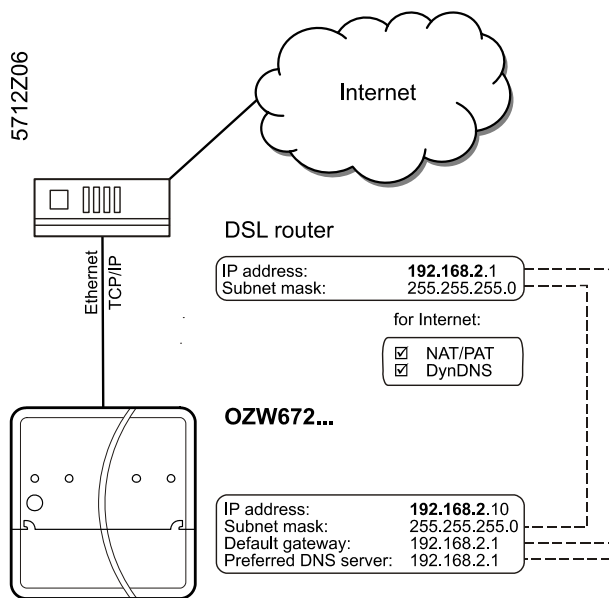

Router

The router settings below are required, when

- Accessing the web server from outside the local area network.
- A message is send via email for a fault.

Notes

Remote access (e.g. DSL router with Internet connection) must already set up. A static IP address or DynDNS-capable controller with DynDNS account is prerequisite for operation via Internet.

Settings:

- NAT/PAT: Translate private parties on public IP addresses and ports.
- DynDNS: The dynamic IP address for the connection must be published if no fixed public IP address is available.

Settings depend on network type and application. The different variants are described in Section 6.1.2.

2.7 Functional check

Test condition Connections must be tested if all settings were made to the web server as well as to system devices.



LAN A PC on the local network is used to test operations via LAN. The log in dialog box must be displayed after entering the local IP address for the web server (see Section 2.2.2).

Internet We recommend using mobile participants with Internet access (Smart phone, mobile phone) to test operation over the Internet. The login dialog box must be displayed after entering the public IP address or plant domain (see Section 3).

Test message receiver Do the test if the web server is to send a message or system report via e-mail for a fault.

Note  The test is also carried out if message suppression is switched on.

Path: Home > 0.5 OZW672... > Settings > Message receiver

Data point	Explanation, example		
Test message receiver Default val: --- Setting val: Message receiver 1..4	Select a message receiver to test the connection to the receiver.	<input checked="" type="radio"/>	—
System report sent Display values: ---, Yes, No	The display changes from "---" to "Yes" after a few seconds. Message sent successfully. No: Message receiver not reached.	<input type="radio"/>	—
Cause Display values: ---, Network cable, DNS setting, Address mail server, Port number mail server, E-mail address receiver, Authentication mail server. See the following table.	"Cause" displays the results of "System report sent". For "Yes" the cause is "---" For "No" the cause is displayed. The first fault is displayed for multiple faults.	<input type="radio"/>	—
Message inhibition Display values: Yes, No	Shows the message suppression switch setting (8) (see Section 1.2).	<input type="radio"/>	—

Cause: Cause of error and problem solution

A specific cause can originate in different sources. The problem must be solved accordingly.

Cause	Cause of error	Solution
---	No error	---
Network cable	No network cable or no active network connected.	Connect cable or active network. LEDs must be lit at Ethernet connection.
DNS setting	DNS server could not be reached or no guaranteed network connection.	Check Setting DNS server, Default gateway, or network connection.

Table continued on next page

Cause	Cause of error	Solution
Address mail server	Address mail server not discovered by DNS server.	Check Address mail server, Default gateway, or network connection.
Port number mail server	Mail server refuses connection or does not answer.	Check Port number mail server. A company proxy server may block Internet connection.
E-mail address receiver	Invalid E-mail address.	Check E-mail address.
Authentication mail server	Mail server refuses connection. Inconsistent Mail server response. "Authentication mail server" contains different errors. Encrypted mail server (i.e. with TLS = Transport Layer Security) may not be supported.	Check "Authentication mail server = Yes" and user name and Password. An invalid "E-mail address sender" can also result in this error.

2.8 Additional settings

Hide devices

You can determine whether a device in the device list can be operated under "Home".

Note

 You can only hide devices on the "Administrator" user level.

Procedure:

1. Device web pages In primary navigation, select.
2. Select the device you want to hide.
3. Click [Hide]

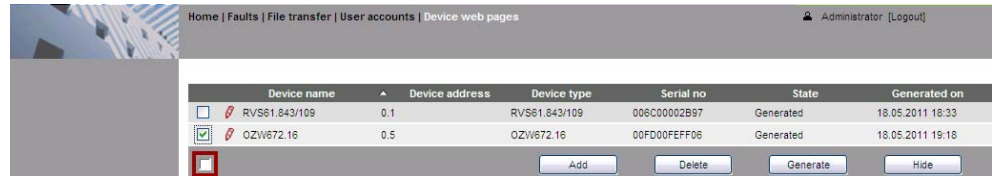



Delete history

Path: Home > 0.5 OZW672... > Settings > Faults

Note

 We recommend deleting the history after you have completed commissioning.

Data point	Explanation, example		
Delete history Default val: No Setting val: Yes	Delete history of all events and messages. Note  : Setting value Yes is a temporary state, i.e. the value automatically returns to No after ca. 2 seconds.	<input checked="" type="checkbox"/>	<input type="checkbox"/>

2.9 Final steps

2.9.1 Check faults

Fault indication

The fault indicator displays the plant state.

Note



No faults may be pending after commissioning. Additional information on faults is available in Section 3.3.

No fault

The fault indicator remains green as long as no fault is pending.

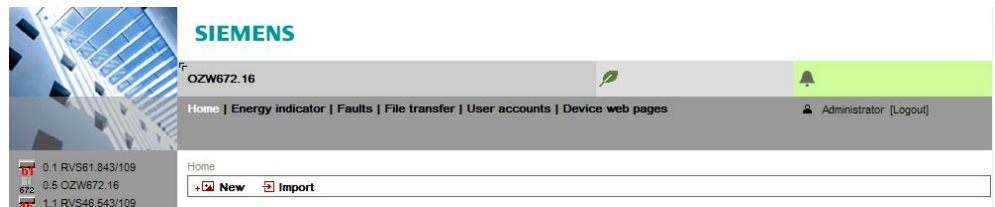

Fault

The fault indicator changes to red for faults.

The most severe plant faults are displayed:

- Device name
- Fault text

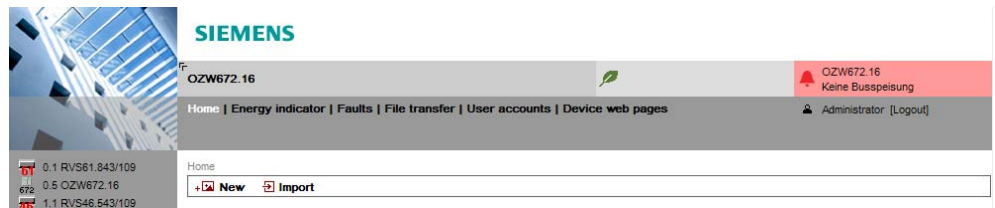

2.9.2 Final steps on web server

Final tasks

The final function checks are conducted on the web server, the cover is mounted and the LEDs checked.

Note



On display and operating elements, see Section 1.2.

Procedure:

1. Unplug USB cable.
2. Switch off message suppression:
 - Remove the cover
 - Message suppression switch (8) must be on "Off"
3. Mount terminal cover.
4. Press Remote (6) button for more than 6 seconds.
 - The web server sends a system report to the defined message receivers.
 - Fault LED (4) displays (flashing) error in establishing communications.
5. On LED must be green.
6. Fault LED must be dark.

2.10 Supply state

Restore default state

The web server can be reset to factory default settings. This is probably a good idea when using the web server for another plant.

Procedure:

1. Simultaneously press buttons Remote ✓ (6) and Service ● (7) for more than 6 seconds.
LED On ⓘ turns off. The web server restarts.
2. Wait until the web server is operational (LED On ⓘ is green).

Notes



When restoring default state:

- All settings are reset to default (also applies to LPB/BSB device address and Ethernet IP address).
- The device list is deleted.
- Uploaded files are deleted.
- Unsent messages are deleted.
- History data is **not** deleted (must be deleted manually; see Section 2.8).

2.11 Update software

We differentiate between the following:

- System definition updates to integrate device descriptions of new devices in the web server.
- Firmware updates to update the web server to the latest firmware version. Firmware updates may also contain new device descriptions (system definitions).

System data update

The web server supports a number of bus devices and differentiates them via device descriptions. A text catalog with various languages contains all web server texts and device descriptions. The system data can be updated on site to add device descriptions for new devices or new languages retroactively.

Note



A system definition update is a simply operational step via web browser that can. See Section 3.4, part "Upload system definitions" for information on uploading.

Firmware update

Local operations on web server required to update firmware so that remote update is not possible. Procedures are communicated for any firmware update accordingly.

Logo update

The logos can be customized. See Section 3.4, part "Upload logos" for information on uploading.

3 Operate using a web browser

This section describes web server and bus device operation via a web browser.

3.1 Overview

Overview

The plant is operated via PC, Smartphone or mobile phone with compatible web browsers via USB interface, LAN/Ethernet or Internet.

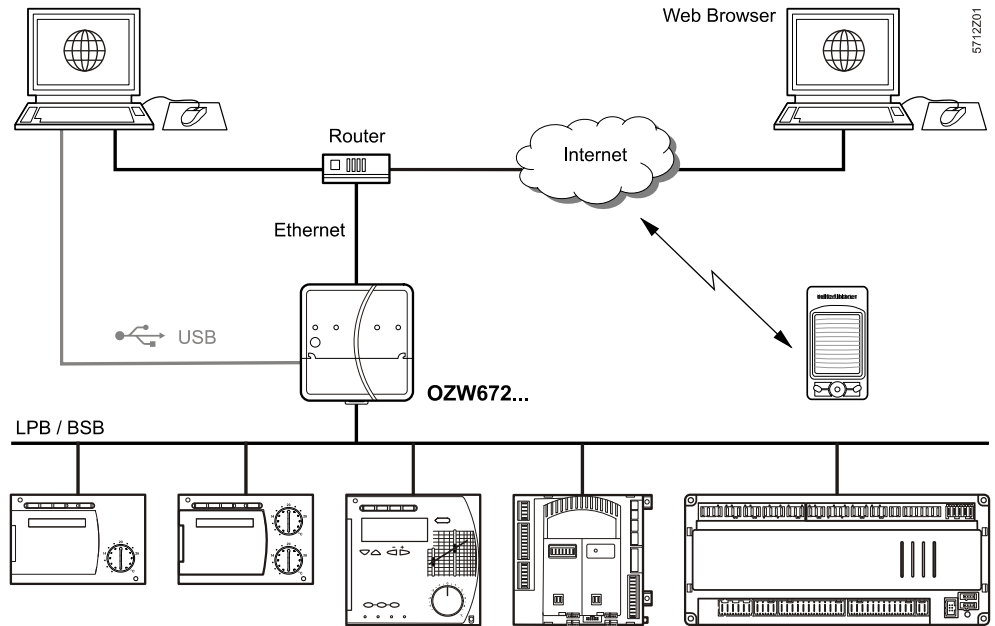

Connection

Enter the IP address for the interface (USB, Ethernet) or the plant's domain name in the web browser's address line.

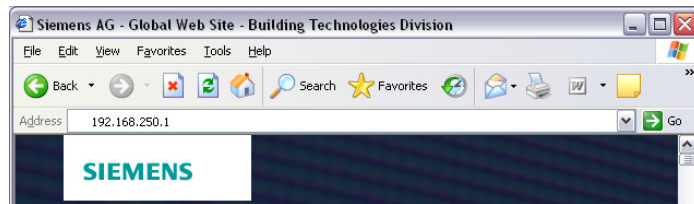

Login

The login follows:

- User name
- Password

Note



You can automate the process by adding the login information to the web browser's address line.

Format: <IP address>/main.app?user=<User name>&pwd=<myPassword>

Example: 10.169.9.121/main.app?user=Administrator&pwd=myPassword

"Deep link"

You can create and save a deep link to go to a sub-page without navigating. The easiest way to do this is to copy the URL for the desired subpage and replace the browser's session ID with user name and password.

Example

Original URL:

http://192.168.250.1/main.app?SessionId=f9d53187-2868-4a6b-8b20-9eca4e859a4d§ion=popcard&id=637&idtype=4

Available as "Deep Link":

http://192.168.250.1/main.app?**user=Administrator&pwd=myPassword**§ion=popcard&id=637&idtype=4

The current, valid login information must be included for syntax "user=<user name>&pwd=<myPassword>".

Note



Deep links can be rendered invalid by generating an associated bus device.

3.2 Operate the plant

Operate the plant

Devices ready for operation are displayed via "Home".

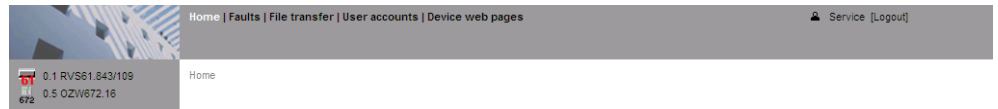

3.2.1 Bus device operation

Bus device operation

Select the device in the left menu pane to operate the bus. Web server displays the top level of the menu tree. From here, you can go to all operating pages and data points.

Example for operating page

Path: Home > 0.1 RVS61.843/109 > Heating circuit 1

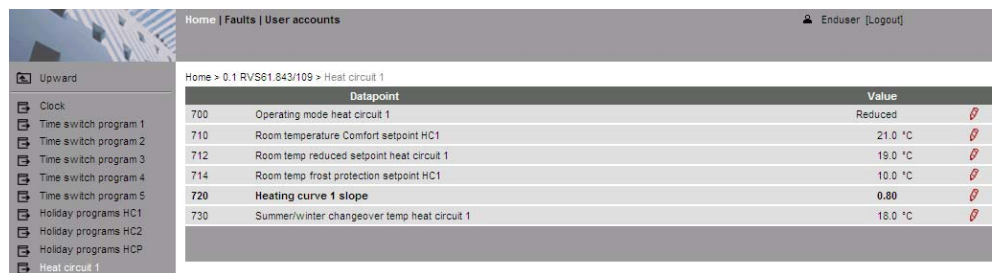

3.2.2 Operate web server

Operate web server

Left-click in the menu to select web server operation. Web server displays the top level of the menu tree. From here, you can go to all operating pages and data points.



Switch views

Only the following parts of the user interface are displayed to operate the web server from a smaller screen or to hide navigation:

- Plant state
- Plant name
- Display

The double arrow in the upper left-hand corner switches the view.

Full screen

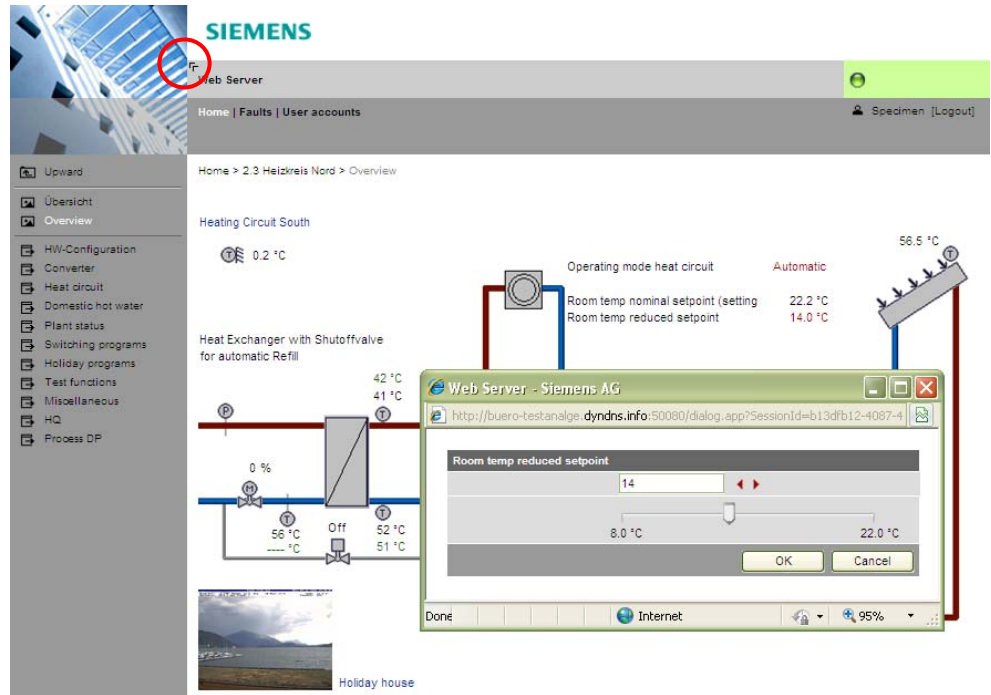

Partial screen

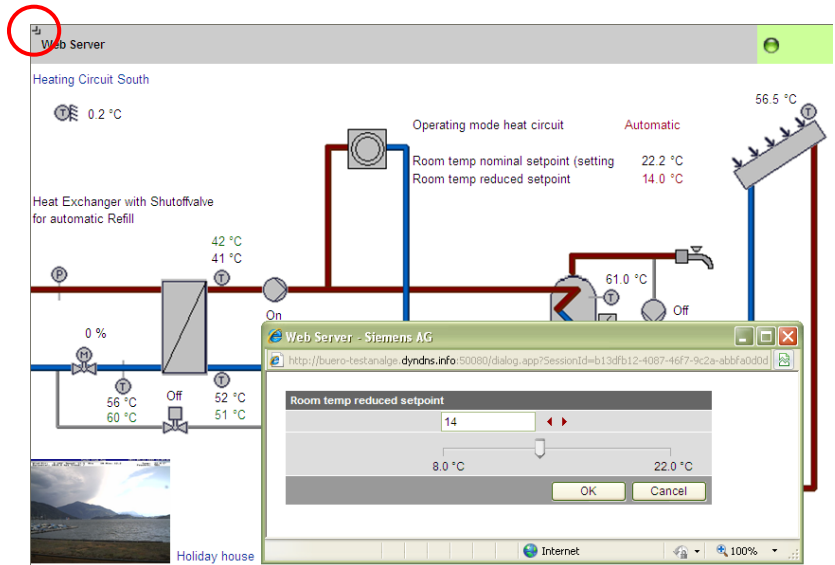

Note







In partial view, navigation to other plant web pages must be implemented using user-defined links. You can return to the full view at any time for navigation.

Time of day/date

Path: Home > 0.5 OZW672... > Time of day/date

Note

-  You can set "Time of day/date" during operation. The clock time master overwrites the time if the web server clock slave does not have remote adjustment (See Section 2.5.1).





Data point	Explanation, example		
Time of day/date Default val: 00:00 1.1.2005 Setting val: Time of day/date	Set the current time and date. Weekday is calculated automatically.		

Message receiver

You can define the times and days for sending messages for each message receiver.

Send messages

Path: Home > 0.5 OZW672... > Message receiver > Message receiver 1...4 > Send messages



Data point	Explanation, example		
Monday...Sunday, Special day Default val: Monday 00:00 On ... Special day 00:00 On ... Setting val: Monday...Sunday, Special day 00:00...24:00 Off / On	Max 3 sending periods can be defined when web servers can send messages for each weekday and special day(s). The previous day's status is transferred to the current day. The default settings is to always send messages.		

Monday	Tuesday	Wednesday
<input checked="" type="checkbox"/> 00:00 On	<input checked="" type="checkbox"/> 00:00 On	<input checked="" type="checkbox"/> 00:00 On
<input checked="" type="checkbox"/> 02:00 Off	<input checked="" type="checkbox"/> 02:00 Off	<input checked="" type="checkbox"/> 02:00 Off
<input checked="" type="checkbox"/> 04:00 On	<input checked="" type="checkbox"/> 04:00 On	<input checked="" type="checkbox"/> 04:00 On
<input checked="" type="checkbox"/> 06:00 Off	<input checked="" type="checkbox"/> 06:00 Off	<input checked="" type="checkbox"/> 06:00 Off
<input checked="" type="checkbox"/> 08:00 On	<input checked="" type="checkbox"/> 08:00 On	<input checked="" type="checkbox"/> 08:00 On
<input checked="" type="checkbox"/> 10:00 Off	<input checked="" type="checkbox"/> 10:00 Off	<input checked="" type="checkbox"/> 10:00 Off

Thursday	Friday	Saturday
<input checked="" type="checkbox"/> 00:00 On	<input checked="" type="checkbox"/> 00:00 On	<input checked="" type="checkbox"/> 00:00 On
<input checked="" type="checkbox"/> 02:00 Off	<input checked="" type="checkbox"/> 02:00 Off	<input checked="" type="checkbox"/> 02:00 Off
<input checked="" type="checkbox"/> 04:00 On	<input checked="" type="checkbox"/> 04:00 On	<input checked="" type="checkbox"/> 04:00 On
<input checked="" type="checkbox"/> 06:00 Off	<input checked="" type="checkbox"/> 06:00 Off	<input checked="" type="checkbox"/> 06:00 Off
<input checked="" type="checkbox"/> 08:00 On	<input checked="" type="checkbox"/> 08:00 On	<input checked="" type="checkbox"/> 08:00 On
<input checked="" type="checkbox"/> 10:00 Off	<input checked="" type="checkbox"/> 10:00 Off	<input checked="" type="checkbox"/> 10:00 Off

Sunday	Special day	Copy
<input checked="" type="checkbox"/> 00:00 On	<input checked="" type="checkbox"/> 00:00 On	From: Monday
<input checked="" type="checkbox"/> 02:00 Off	<input type="checkbox"/> 00:00 Off	To: <input type="checkbox"/> Monday <input type="checkbox"/> Tuesday
<input checked="" type="checkbox"/> 04:00 On	<input type="checkbox"/> 00:00 Off	<input type="checkbox"/> Wednesday <input type="checkbox"/> Thursday
<input checked="" type="checkbox"/> 06:00 Off	<input type="checkbox"/> 00:00 Off	<input type="checkbox"/> Friday <input type="checkbox"/> Saturday
<input checked="" type="checkbox"/> 08:00 On	<input type="checkbox"/> 00:00 Off	<input type="checkbox"/> Sunday <input type="checkbox"/> Special day
<input checked="" type="checkbox"/> 10:00 Off	<input type="checkbox"/> 00:00 Off	<input type="button" value="Copy"/>

Notes

-  Select the checkbox  to enable active switching points.
- Click [Copy] to copy the switching times for any weekday to a number of other days .
- Click [Check] to check the data before it is saved.

Holidays/special days

Path: Home > 0.5 OZW672... > Message receiver > Message receiver 1...4 > Holidays/special days

Data point	Explanation, example		
Entry 1...16 Default val: --- Setting val: Beginning End Reason Annually	Each recipient has a yearly calendar to enter holidays and special days. Holiday or special day can be selected as Reason . Beginning and End of the periods can be indicated with date and time. Selecting Annually repeats the periods each year.		

	Beginning	End	Reason	Annually
1	<input checked="" type="checkbox"/> <input type="checkbox"/> 14.07.09 00:00	<input type="checkbox"/> <input type="checkbox"/> 29.07.09 23:59	Holidays	<input type="checkbox"/>
2	<input checked="" type="checkbox"/> <input type="checkbox"/> 24.12.** 00:00	<input type="checkbox"/> <input type="checkbox"/> 02.01.** 23:59	Holidays	<input checked="" type="checkbox"/>
3	<input checked="" type="checkbox"/> <input type="checkbox"/> 01.08.** 00:00	<input type="checkbox"/> <input type="checkbox"/> 01.08.** 23:59	Special day	<input checked="" type="checkbox"/>
4	<input type="checkbox"/> <input type="checkbox"/> 01.01.00 00:00	<input type="checkbox"/> <input type="checkbox"/> 01.01.00 23:59	Holidays	<input type="checkbox"/>
5	<input type="checkbox"/> <input type="checkbox"/> 01.01.00 00:00	<input type="checkbox"/> <input type="checkbox"/> 01.01.00 23:59	Holidays	<input type="checkbox"/>
6	<input type="checkbox"/> <input type="checkbox"/> 01.01.00 00:00	<input type="checkbox"/> <input type="checkbox"/> 01.01.00 23:59	Holidays	<input type="checkbox"/>
7	<input type="checkbox"/> <input type="checkbox"/> 01.01.00 00:00	<input type="checkbox"/> <input type="checkbox"/> 01.01.00 23:59	Holidays	<input type="checkbox"/>
8	<input type="checkbox"/> <input type="checkbox"/> 01.01.00 00:00	<input type="checkbox"/> <input type="checkbox"/> 01.01.00 23:59	Holidays	<input type="checkbox"/>
9	<input type="checkbox"/> <input type="checkbox"/> 01.01.00 00:00	<input type="checkbox"/> <input type="checkbox"/> 01.01.00 23:59	Holidays	<input type="checkbox"/>
10	<input type="checkbox"/> <input type="checkbox"/> 01.01.00 00:00	<input type="checkbox"/> <input type="checkbox"/> 01.01.00 23:59	Holidays	<input type="checkbox"/>
11	<input type="checkbox"/> <input type="checkbox"/> 01.01.00 00:00	<input type="checkbox"/> <input type="checkbox"/> 01.01.00 23:59	Holidays	<input type="checkbox"/>
12	<input type="checkbox"/> <input type="checkbox"/> 01.01.00 00:00	<input type="checkbox"/> <input type="checkbox"/> 01.01.00 23:59	Holidays	<input type="checkbox"/>
13	<input type="checkbox"/> <input type="checkbox"/> 01.01.00 00:00	<input type="checkbox"/> <input type="checkbox"/> 01.01.00 23:59	Holidays	<input type="checkbox"/>
14	<input type="checkbox"/> <input type="checkbox"/> 01.01.00 00:00	<input type="checkbox"/> <input type="checkbox"/> 01.01.00 23:59	Holidays	<input type="checkbox"/>
15	<input type="checkbox"/> <input type="checkbox"/> 01.01.00 00:00	<input type="checkbox"/> <input type="checkbox"/> 01.01.00 23:59	Holidays	<input type="checkbox"/>
16	<input type="checkbox"/> <input type="checkbox"/> 01.01.00 00:00	<input type="checkbox"/> <input type="checkbox"/> 01.01.00 23:59	Holidays	<input type="checkbox"/>

Notes



- Select checkbox to select active entries.
- Select "Annually" to set repetitive switching points.
- Click [Check] to check the data before it is saved.

3.2.3 Web server diagnostics

Diagnostics

The following information is required to identify product version and settings. Information on faults is available in Section 3.2.2.

Device information

Device information helps identify the web server.

Web server



Path: Home > 0.5 OZW672... > Device information

Data point	Explanation, example		
Plant name	Web server or plant name.	<input type="checkbox"/>	<input type="checkbox"/>
Web server type	Web server product number (ASN).	<input type="checkbox"/>	<input type="checkbox"/>
Production number	Device number from production.	<input type="checkbox"/>	<input type="checkbox"/>
Software version	Software version of the web server.	<input type="checkbox"/>	<input type="checkbox"/>
Build	Revision status for the software.	<input type="checkbox"/>	<input type="checkbox"/>
Hardware version	Web server hardware version.	<input type="checkbox"/>	<input type="checkbox"/>
Field bus module 1	Field bus module 1 type.	<input type="checkbox"/>	<input type="checkbox"/>
Software version	Field bus module 1 software version.	<input type="checkbox"/>	<input type="checkbox"/>
Message inhibition	Shows the setting of the message suppression switch (8).	<input type="checkbox"/>	<input type="checkbox"/>

LPB / BSB

The following information displays the current settings and states on the LPB / BSB bus.



Path: Home > 0.5 OZW672... > Device information > LPB / BSB

Data point	Explanation, example		
Connected bus	The web server autonomously identifies the bus system connected. Possible values ---, LPB, BSB.	<input type="radio"/>	<input type="radio"/>
Segment number	Part of the LPB device address.	<input type="radio"/>	<input type="radio"/>
Device number	Part of the LPB device address.	<input type="radio"/>	<input type="radio"/>
Clock time source	<ul style="list-style-type: none"> • Autonomous: Time/date is created from the Quartz of the web server. No synchronization with bus devices. • Slave with remote setting: Web server receives time/date from master. The master supplies both date and time on the web server and is then sent to all bus devices. • Slave without rem setting: Web server receives time/date from master. The web server date/time setting is not sent to the master. The master resets date/time. • Master: Time/date is created from the Quartz of the web server. The web server supplies both date and time to all bus devices. <p>Recommended: Configure the web server as Master and the bus device as slave with or without remote setting.</p>	<input type="radio"/>	<input type="radio"/>
Number of devices max	Maximum possible number of devices monitored by the web server on the LPB/BSB bus.	<input type="radio"/>	<input type="radio"/>
Number of devices current	Actual number of devices monitored by the web server on the LPB/BSB bus.	<input type="radio"/>	<input type="radio"/>
Last change	Time of last change to device list.	<input type="radio"/>	<input type="radio"/>

Ethernet

You can consult the following information as needed to analyze problems on the Ethernet. It displays the current settings for the subnet.

Path: Home > 0.5 OZW672... > Device information > Ethernet

Data point	Explanation, example		
IP address	IP address of the web server. The IP address for the web server on the Ethernet ex works is: 192.168.2.10	<input type="radio"/>	<input type="radio"/>
Subnet mask	The Subnet mask sets the size of the subnet. A value of 255 masks the partial network; a value of 0 masks the device portion of the IP addresses on the subnet. Devices must have the same partial network to communicate directly. The factory setting for the web server subnet mask 255.255.255.0 .	<input type="radio"/>	<input type="radio"/>
Default gateway	The Default gateway connects the subnetwork for the web server to additional networks, e.g. the Internet. The router typically is the default gateway.	<input type="radio"/>	<input type="radio"/>
Preferred DNS server	Preferred DNS server Required to send e-mails. The router typically is the DNS server for the web server.	<input type="radio"/>	<input type="radio"/>
Alternate DNS server	An alternative DNS server is only defined for redundant systems and is typically empty.	<input type="radio"/>	<input type="radio"/>
Physical address	The physical address is a unique identification for the Ethernet interface.	<input type="radio"/>	<input type="radio"/>

3.3 Faults

3.3.1 Overview

Fault overview

The "Faults" function displays the most severe fault on a device in the device list. It is available to all user levels. The following information helps identify the fault:

- Fault
- Device name
- Fault information (date, time, fault code).
- Fault text
- Device address
- Device type

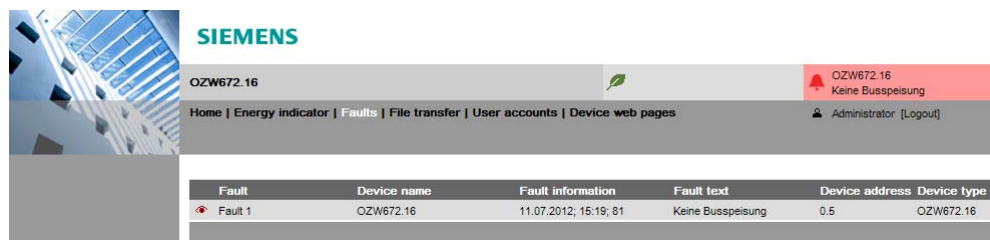

The screenshot shows a Siemens web interface for device OZW672.16. A red alert banner at the top right indicates a fault: "OZW672.16 Keine Busspeisung". Below the banner is a navigation menu with "Home | Energy indicator | Faults | File transfer | User accounts | Device web pages". A user profile for "Administrator [Logout]" is visible in the top right. The main content area contains a table with the following data:

Fault	Device name	Fault information	Fault text	Device address	Device type
 Fault 1	OZW672.16	11.07.2012; 15:19; 81	Keine Busspeisung	0.5	OZW672.16

Note

 Click  to go to the corresponding device's web operation.



3.3.2 Web server faults

You can display detailed information on all faults via the "Home" menu.

Faults current local

Displays all web server faults.

Path: Home > 0.5 OZW672... > Faults current > Local

Data point	Explanation, example		
Fault 1...10	Displays for each fault: <ul style="list-style-type: none"> • Fault information (date, time, fault code). • Fault text 	<input type="radio"/>	<input type="radio"/>



Note

 Overview of all web server faults included in Section 7.1.

System faults

The most severe faults are displayed for each device on the bus.

Path: Home > 0.5 OZW672... > Faults current > System > Fault 1...n

Data point	Explanation, example		
Fault 1..n	Displayed under "Fault 1..n": Device name, Fault information, Fault text, Device address, Device type.	<input type="radio"/>	<input type="radio"/>

Note

 Faults for bus devices are listed in the documentation for the corresponding devices.

3.4 File transfer

"File transfer" helps to

- Upload documents to the web server.
- Download message history as Excel or text file.
- Upload logos.
- Upload system definitions.

Documentation Upload

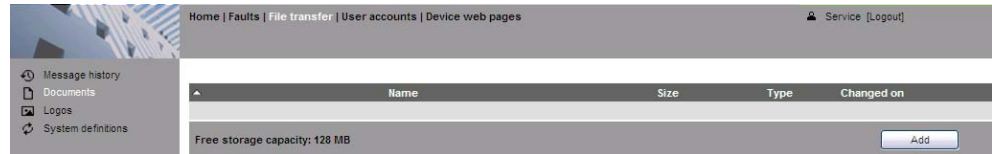

Procedure:

1. Select File transfer in primary navigation.
2. Click [Add]

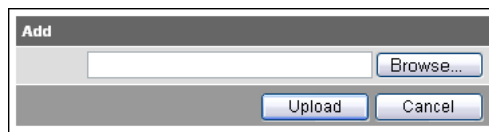

3. Select the desired file.
4. Click [Upload] to finish.

Notes



- Make sure there is enough memory for uploading.
- The Administrator and Service levels allow for uploading documents.

Message history download

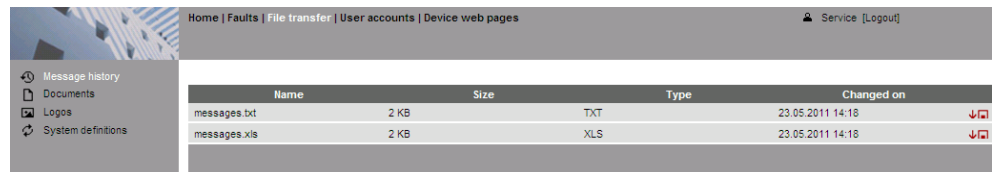

Procedure:

1. Select Message history from secondary navigation.
2. Click  next to the desired document (messages.txt: Text file, messages.xls: Excel file).

The "File download" dialog box opens.

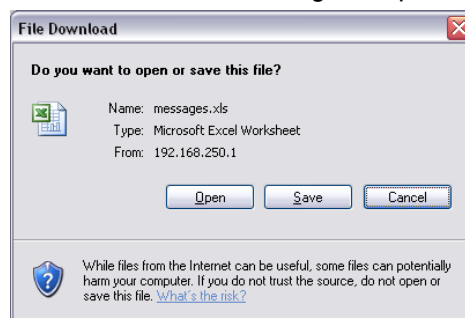

3. Open the file with the application or save it to any location.

Notes



- Message history export is available to administrator and service user levels.
- The message history remains intact when resetting the web server to default.

History data

The message history includes the last 500 events on faults, fault messages, and system reports. It contains the following information:

- Plant information:
 - Plant name
 - Phone number plant
- Information per entry:
 - Event
 - Plant section, i.e. device name (LPB/BSB address)
 - Date of occurrence
 - Time of occurrence
 - Fault code+text
 - Transmission date
 - Transmission time
 - Message receiver
 - Cause

A	B	C	D	E	F	G	H	I
1	Plant name	Demo HCS						
2	Phone number plant	+41794112134						
3	Event	Plant section	Date of occurrence	Time of occurrence	Fault code+text	Transmission date	Transmission time	Message receiver
4	Fault coming	Pressure sensor (Fault input 1) (0.5)	2010.02.16	13:30:49	171: Pressure too high			
5	Message OK	Pressure sensor (Fault input 1) (0.5)	2010.02.16	13:30:49	171: Pressure too high	2010.02.16	13:30:56	1: +41798194250
6	Message OK	Pressure sensor (Fault input 1) (0.5)	2010.02.16	13:30:49	171: Pressure too high	2010.02.16	13:30:59	2: service@siemens.com
7	Fault going	Pressure sensor (Fault input 1) (0.5)	2010.02.16	13:31:03	0: Pressure normal			
8	Message OK	Pressure sensor (Fault input 1) (0.5)	2010.02.16	13:31:03	0: Pressure normal	2010.02.16	13:31:11	1: +41798194250
9	Message OK	Pressure sensor (Fault input 1) (0.5)	2010.02.16	13:31:03	0: Pressure normal	2010.02.16	13:31:14	2: service@siemens.com
10	Fault coming	RVS61.843/M 09 (0.1)	2010.02.17	10:37:59	10: Outside temperature			
11	Message OK	RVS61.843/M 09 (0.1)	2010.02.17	10:37:59	10: Outside temperature	2010.02.17	10:38:06	2: service@siemens.com
12	Fault going	RVS61.843/M 09 (0.1)	2010.02.17	11:58:02	0: No fault			
13	Message OK	RVS61.843/M 09 (0.1)	2010.02.17	11:58:02	0: No fault	2010.02.17	11:58:06	2: service@siemens.com

Upload logos

Procedure:

1. Select Logos from secondary navigation.
2. Save existing logo(s) as needed (see below).
3. Click .

4. Select the desired file.
Adhere to maximum dimensions (see Notes).
5. Click [Upload]
6. Delete the browser cache
(Internet Explorer: Ctrl+F5, Firefox: Ctrl+R).

Save logos:

1. Click "Logo 1" or "Logo 2". The browser window opens with the logo.
2. Right-click the log and save to the desired location via "Save Image As".

Notes



- Log file transfer is available to administrator and service user levels.
- Allowed file formats: PNG, GIF, JPG, BMP.
- The left logo (Logo 1) has max. 625 x 54 pixels.
- The right logo (Logo 2) has max. 200 x 54 pixels.
- The original logos are restored when resetting the web server to default.

Upload system definitions

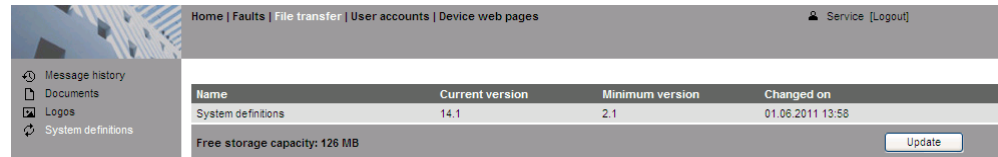

Procedure:

1. System definitions Select from secondary navigation.
2. Click [Update]



3. Select the desired file.
4. Click [Upload] to finish.
5. Restart web server with power-down, power-up.
6. You must recreate the devices following a system definition upload.

Notes



- System definition file transfer is available to administrator and service user levels.
- Uploading and installing make take more than 5 minutes.

System definitions

System definitions comprise:

- Device descriptions.
- Text catalogs in each user language.
- Units catalog.

The device web pages use the uploaded system definitions to properly display devices and menus.

You must generate all device web pages following successful uploading. This applies the new system definitions.

The system definitions must be compatible with the web server's software version. If incompatible, an associated message is displayed and the old system definitions remain as is.

Note



Make sure there is at least 60 MB free memory on the web server when uploading. If not, check the contents via File transfer > Documents.

3.5 Operation with ACS790

The following functions are available with ACS790:

- Commissioning with device search.
- Popcard.
- Plant diagrams:
For standard applications for the LPB/BSB controller, web-capable plant diagrams may be exported from ACS790 and import them to the web server.
- Parameterization:
Read and write parameter sets.
- Commissioning protocol.
- Offline trend.

For more details, see data sheet N5649.

Empty page

4 Visualize plants

4.1 Overview

Web server OZW672... visualizes technical equipment in buildings via plant web pages. The plant is operated and monitored via one or more generated plant web page(s).

Import plant diagrams

Web-capable plant diagrams may be exported from ACS790.

Create own plant web pages

You can freely design plant web pages.
As a hybrid form, you can also modify and extend imported plant diagrams.

Web page elements

Plant web pages are designed with the following web page elements:

- Background image.
- Data point elements.
- Text elements.
- Link elements.
- Partial pictures.

Data point elements are used to operate and monitor read and write values for devices connected via the bus and the web server.

Edit/view mode

Plant web pages are generated online in the web browser.
The web page designer with administrator rights also switches the plant web pages to edit mode.
Other users can query and operate the last saved visualization during the transition phase.
Plant web pages return to view mode once the changes are saved. The new state is now available online at this point.

Note



The switch from an LPB to a BSB bus system and vice versa is not recommended since this renders the defined plant web pages unusable.

4.2 Example of a plant web page

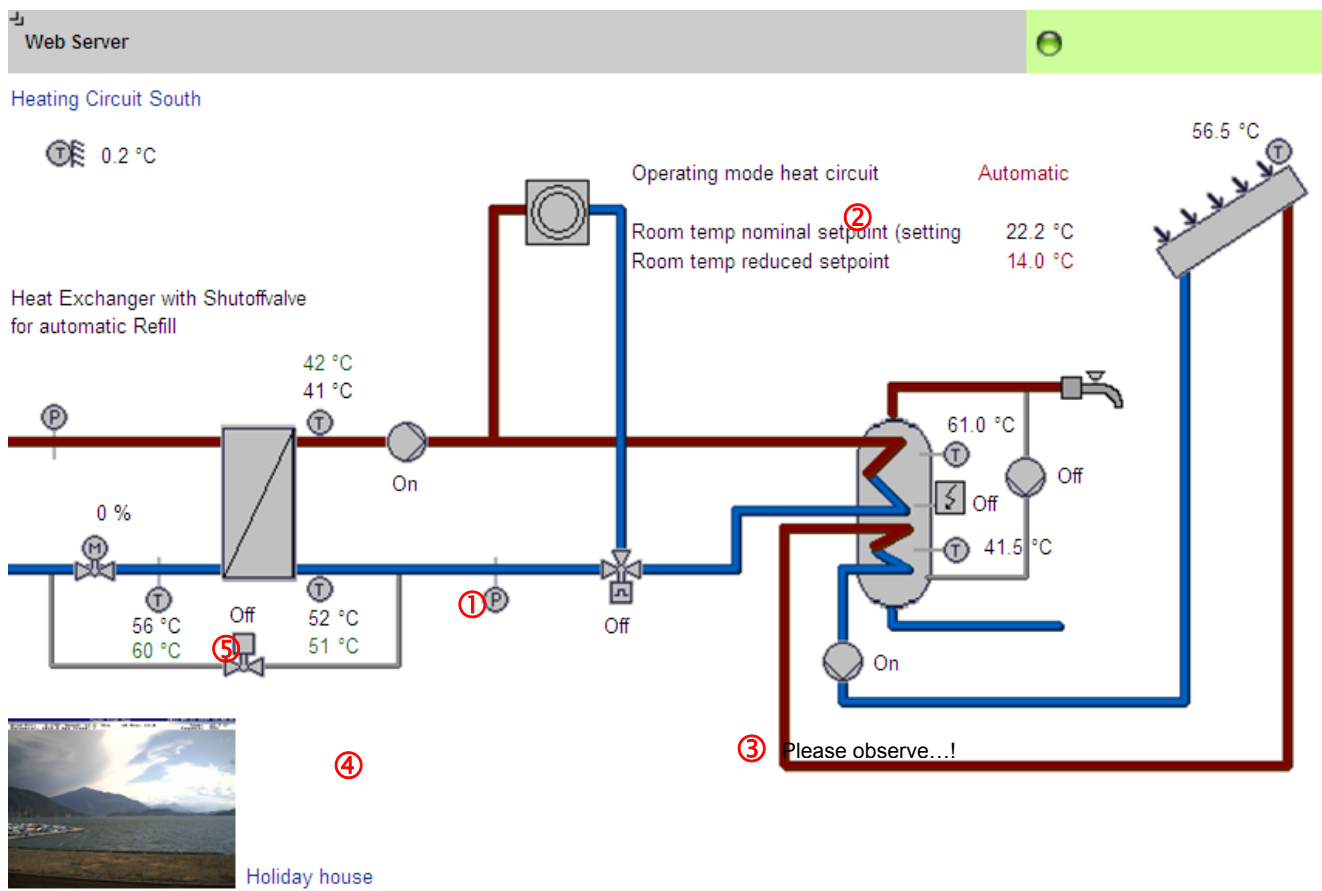

- ① **Background image** All surfaces, symbols and the diagram.
- ② **Data point element** Two data point elements: Room temperature nominal and reduced setpoint.
- ③ **Text element** Explanation text.
- ④ **Link element** Link to Internet.
- ⑤ **Partial picture element** Integrated web cam image.

The example above is an extension to a web-capable plant diagram downloaded from HIT.

The extension consists of additional, explanatory text (3), a link to the Internet (4) and an integrated web cam image (5), that is updated periodically (e.g. every minute).

4.3 Plant web page features

Background image	<p>A plant web page has an expandable area that can be used to place web page elements. The display area has a minimum size of 800 px (width) and 580px (height).</p> <p>The minimum display area is filled with a transparent background image if no background image is explicitly selected.</p> <ul style="list-style-type: none">• The display area can be expanded to any size by adding a larger background image.• The following types are accepted: png, jpg, gif and bmp; we do not recommend using bmp due to the file size.
Position in secondary navigation	<p>Multiple plant web pages are listed from top to bottom in the secondary navigation per their "Position". The plant web page is built and displayed at "Position"=1 when going to a home or device node. The "Position" can be set in secondary navigation via "New > Properties > Position" and for existing plant web site via "Properties > Position".</p>
Front side / Background	<p>The following applies to levels within a plant web page:</p> <ul style="list-style-type: none">• The background picture is located in the background.• The group of partial pictures are in front.• The group with all remaining elements are in front.• More recently added elements are on top of previously added elements within the group of partial pictures and remaining elements. <p>Please note the following for the last statement:</p> <ul style="list-style-type: none">• If an element is deleted as part of editing and another element added, the new element jumps to the level of the deleted one. This level is not always the top level.• You must add a new element as part of new editing to ensure that the new elements are placed at the top (finish with OK and re-click edit).
Show/Hide	<p>Plant web pages are hidden for a hidden device with appended plant web pages. The associated plant web pages are displayed again if the device is re-generated and displayed (see Note in Section 2.8).</p>
Delete	<p>Appended plant web pages are irretrievably deleted once a device is deleted. The same is true when you reset the web server.</p>
Changes to controller configuration	<p>Any change to the controller configuration creates differences between the controller and the mapping on the web server. This impacts plant web pages as well where data point elements access the controller via the web server map. You must run "Generate" each time you change the controller configuration (See Section 2.4 for workflow).</p>
Key variables	<p>Any number of plant web pages per web server are possible.</p> <ul style="list-style-type: none">• The web server has 180 MB in memory.• You should pay special attention to image file size to save memory; (current available memory is available at "File transfer > Documents")• A maximum of 100 elements may be added on a plant webpage from one web page element type (e.g. a maximum of 100 data point elements).

4.4 Toolbar



Note

The menus described below are only displayed and operable on the "Administrator" user level.

View mode, no web page available

The following toolbar is displayed at home and on the device nodes, if no plant web page is generated:

Home > 0.5 OZW672.16

 New  Import

Menu	Description
New	Create new plant web page.
Import	Import archived plant web page. Plant web pages are archived and imported as .tar files.

View mode, web page available

The toolbar is as follows for an existing plant web page:

Home > Plant diagram new





 Properties |  New  Import |  Edit  Copy  Export |  Delete

Menu	Description
Properties	Properties dialog for the plant web page. Enter the same as for "New". Furthermore, "Replace datapoint addresses" address data points with the same names on another bus device.
New	Create another plant web page.
Import	Import archived plant web page.
Edit	Switch to edit.
Copy	Copy selected plant web page to another device node.
Export	Export selected plant web page as .tar archive.
Delete	Deleted selected plant web page.

Edit

Click Edit to switch the plant web page to edit mode. The toolbar is as follows:

Home > Plant diagram new

 Edit  Datapoint  Text  Link  Partial picture

Menu	Description
Datapoint	Embed data point element to web page. A data point element consists of two fields: <ul style="list-style-type: none"> Data point value for a device connected via the bus or the web server. Data point text.
Text	Add free text (single line) to plant web page. The text is entered in the field "Displayed name".
Link	Hyperlink to other plant web pages, to a document or an external web page.
Partial picture	Add additional picture to plant web page. "Link external" integrates periodically updated, external images (e.g. web cams).

User levels

Only an administrator may generate and change visualization. User levels have the same rights for operation and monitoring.

4.5 Import web-capable plant diagrams

Prerequisites

- The drafter is logged on to the web server as an administrator.
- Web server is connected with the bus with one or more bus devices.
- The devices web page for the bus device is generated per Section 2.4. The web server menu tree and data point information for the controller is now available.

Export plant diagram from ACS790

Procedure on ACS790:

- Select bus device.
- Copy standard diagram and re-add to the same bus device (standard diagram cannot be exported). The copied icon is light blue.
- Rename diagram.
- Export diagram using the "Export to..." function. In the data type dialog field, select *.tar and save.

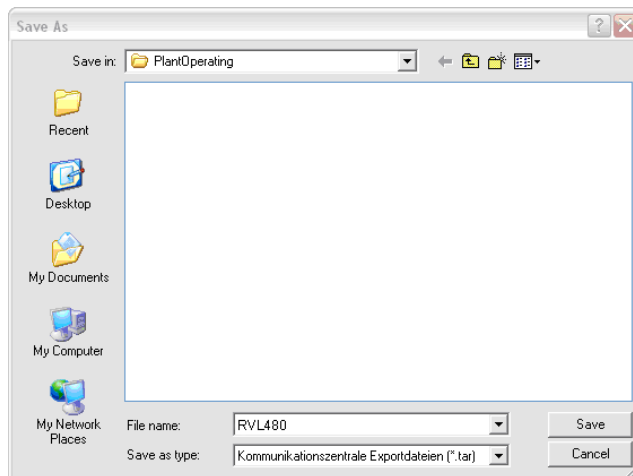

Import plant diagram to web server

Workflow on web server:

1. Start at the home node in secondary navigation for the desired bus.
2. Click Import.
The import dialog ("file name (*.tar)") is displayed.
3. "Search..." to go to the .tar file saved on the computer.
4. Click Open.
5. Click Upload.
Import information is displayed while the file is being read; the property dialog box now opens.
6. Check replacement function with "Replace datapoint addresses".
7. From the dropdown list box, select the bus address for the connected controller.

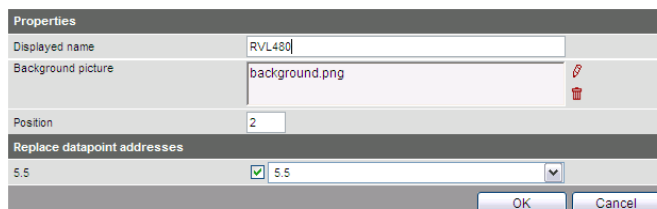

8. Click [OK] to start.
The plant diagram is finished.

Result

The bus device or plant can now be operated and monitored via the web-based plant diagram. The default display is as follows:

- Operating values (e.g. operating mode Auto, Comfort, etc.) is displayed in red. The cursor changes to a hand symbol when you move it over the display. Click to open the applicable settings dialog box.
- Set points are displayed in orange; actual values in white.

Note

For reasons of compatibility and regardless of the user level, individual data points for the bus device may not be mapped to the plant diagram.

- The data point text "Data point not found" is displayed.
- Three question marks "???" are displayed as the data point value.

See Section 4.6 for any post editing.

4.6 Create own plant web pages

You can generate complete plant web pages yourself. As an option, you can change and extend any imported plant diagrams (See Section 4.5) as needed. This section presents the steps required to generate and design a customized plant web page.

Prerequisites

- The drafter is logged on to the web server as an administrator.
- Web server is connected with one or more bus devices.
- The devices web page for the web server and the bus devices is generated per Section 2.4. The web server menu tree and data point information is now available.

Create plant web page

The following describes how to create a plant web page and add a background image.

1. Go to home nodes or to a device node.
2. Click New.
The properties dialog box is displayed.
3. In the Displayed name field, enter the name for the plant web page (is displayed later in the navigation area for the web server).
4. Click the red pencil in the Background picture field.
The add dialog box is displayed.
5. Search to go to the desired background picture.
6. Click Open.
7. Click Upload.
The file name for the selected picture is displayed in the background picture field.
8. Click OK.
The plant web page is now saved with the background picture.

Add data point element

The following describes how to add a data point element to a newly created plant web page.

1. Click Edit.
The plant web page switches to edit.
2. Click Datapoint.
The data point dialog box is displayed.
3. Click the red pencil in the Datapoint address field.
The data point address dialog box is displayed.
4. Go to the data point via device, menu text(s).
5. Select Datapoint.
The entire data point path is entered in the data point address field.
6. Set the X/Y position for the data point field in the display area.
7. Modify formats such as text field size for "Datapoint - value" and "Datapoint - text" as needed.
8. Click Apply to check the results of the change in formatting as a preview to the plant web page.
9. If satisfied, click OK to finish.
10. Click OK to change to view.
The data point value was read and is displayed.

Notes

- Double-click the data point element in edit to reopen the settings dialog box for an already created data point element. The data point element can also be deleted in the settings dialog box.
This note applies as well to other web page elements.
- As an alternative to setting the X/Y position in the data point dialog box, you can also position data point elements using drag and drop in edit mode. The element can no longer be moved after switching to view mode.
This note applies as well to other web page elements.
- The X/Y position in the data point dialog box is anchored to the text in the data point value field and its alignment. In conjunction with the alignment functions, the data point field moves to the right for left align and to the left for right align (see the following graphic).
This note refers as well to text and link elements accordingly.

Alignment

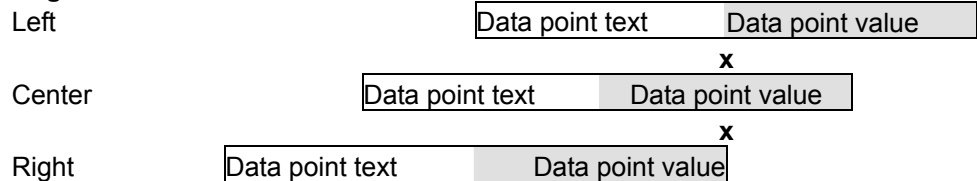

Notes

- The "x" displays the changed position of the anchor.
- The alignment of all the data point texts is left aligned.

Add text element

The following describes how to add informational text to a plant web page.

1. Click Edit.
The plant web page switches to edit.
2. Click Text.
The text dialog box is displayed.
3. Enter the desired text in the Displayed name field.
4. Set the X/Y position for the text field in the display area.
5. Format as needed.
6. Click Apply to check the results of formatting in a preview.
7. If satisfied, click OK to finish.
8. Click OK to change to view.

Notes

Text elements are single lines.

Only a limited number of fonts are available for texts:

- Small 10pt
- Normal 12pt
- Large 16pt
- XL 24pt

Add link element

The following describes how to add two lines to the plant web page:

- To another plant web page.
- To an external web page.

The link to a document is not displayed, but works accordingly.

Link to another plant web page

1. Click Edit.
The plant web page switches to edit.
2. Click Link.
The link dialog box is displayed.
3. Enter the desired text for display in the Displayed name field.
4. Select Link to in the "Plant diagram" field.
5. Click the red pencil in the same field.
The plant diagram dialog box is displayed with all plant diagrams available on the web server.
6. Select the desired plant diagram.
Enter the path for the plant diagram in the "Link to" field.
7. Set the X/Y position for the link field in the display area.
8. Format the link as needed.
9. Click Apply to check the results of formatting in a preview.
10. If satisfied, click OK to finish.
11. Click OK to change to view.
The link is enabled immediately in the view mode: Click to open the corresponding plant web page.

Tip

We recommend adding a link on the target web page to return to the previous page.

Notes

- Links are broken after importing a plant web page to another web server and must be restored per the instructions above.
- The links to other plant web pages are also broken after a firmware update for web pages exported in advance and then imported and must be restored per instructions above.

Links to an external web page

1. Click Edit.
The plant web page switches to edit.
2. Click Link.
The link dialog box is displayed.
3. Enter the desired text for display in the Displayed name field.
4. Select external link in the Link to field.
5. Click the red pencil in the same field.
The link external dialog box is displayed.
6. Enter the desired URL.
7. Check the correctness of the entry: The Internet page is opened.
8. Confirm with OK.
9. Enter the URL in the "Link to" field.
10. Format the link as needed.
11. Click Apply to check the results of formatting in a preview.
12. If satisfied, click OK to finish.
13. Click OK to change to view.
The link is enabled immediately in the view mode: Click to open the corresponding web page.

Add partial picture

The following describes how to add two partial pictures to the plant web page:

- A static picture downloaded to the web server.
- A link to an external picture on a server, e.g. continuously updated images from a webcam.

Static partial picture

1. Click Edit.
The plant web page switches to edit.
2. Click Partial picture.
The partial picture dialog box is displayed.
3. Select "Picture source" in File field.
4. Click the red pencil in the same field.
The add dialog box is displayed.
5. Click Search.
6. Go to desired image file.
7. Click Open.
8. Click Upload.
Enter the file name for the selected image in the Field Source field.
9. Edit Position and Scaling.
10. Click Apply to check the results of formatting in a preview.
11. If satisfied, click OK to finish.
12. Click OK to change to view.

Dynamic partial picture

1. Click Edit.
The plant web page switches to edit.
2. Click Partial picture.
The partial picture dialog box is displayed.
3. Select "Picture source" in Link external field.
4. Opens the web cam image on the Internet.
5. Right-click webcam image.
6. Select properties for webcam image.
7. Highlight the address (URL) of the webcam image and copy to clip board.
8. Click the red pencil in the Source Picture field.
The link external dialog box is displayed.
9. Add the URL for the webcam image.
10. Check the correctness of the entry: The webcam image is opened.
11. Click OK.
12. Edit Position and Scaling.
13. Click Apply to check the results of formatting in a preview.
14. If satisfied, click OK to finish.
15. Click OK to change to view.

5 "Energy indicator" function

5.1 Introduction

5.1.1 Function description

"Energy indicator" function

Function "Energy indicator" is available on the OZW672... web server from V4.0.

The web server uses the "Energy indicator" function to read selected data point values from the LPB and BSB bus devices and to compare the values to energy-related limit values, or so-called "Green limits".

The data points are also monitored for adherence to the "Green limits". As a result, the "Energy indicator" is displayed in the form of a tree leaf.

Monitored data points and their "Green limits"

The monitored data points and their "Green limits" depend on the device type. The following applies e.g. to a controller:

Monitored data points	"Green limits" (technical energy limit values)
Comfort setpoint	>21 °C
Reduced setpoint	>15 °C
Setpoint readjustment	>± 1.0 K (± readjustment has 2 "Green limits")
Operating mode	Automatic, Reduced, Protection → "Green leaf" Comfort / Continuous → "Orange leaf"

Notes

The "Green limits" are used only together with the "Energy indicator" function. They do **not** represent process or safety limit values which trigger e.g. fault messages or turn off the plant in the event of limit violations.

Users also are allowed to change data point values (setpoints). E-mail messages from the system then remind the user that a value or values were changed.

Tree leaf as "Energy indicator"

Green leaf 

"Green leaf" → Green tree leaf, leaf pointing up.

- The "Green leaf" symbol indicates that a data point value has not exceeded its "Green limit", i.e. the value is within a "green" range in terms of energy consumption.

Orange leaf 

"Orange leaf" → Orange tree leaf, leaf pointing down.

- The "Orange leaf" symbol indicates that a data point value has exceeded its "Green limit", i.e. the value is outside a "green" range in terms of energy consumption.

Grey leaf 

"Gray leaf" → Gray tree leaf, horizontal leaf.

- The "Grey leaf" symbol indicates that a data point value is not current, e.g. transmission of a data point value is incomplete, or there is no data communication with the bus.

No tree leaf

- The data point is not monitored via the "Energy indicator" function.

Standard EN 15232

The "Energy indicator" function is based on standard EN 15232 "Energy efficiency in buildings".

Example: Web page "Energy indicator"

Web page with "Energy indicator" function; example with data points from "Heat circuit 1" and open dialog box to set data point value "Room temperature Comfort setpoint HC1" and its "Green limit".

Energy indicator	Datapoint	Value	Green limit(s)
	<input checked="" type="checkbox"/> Operating mode heat circuit 1	Automatic	Protection, Automatic, Reduced
	<input checked="" type="checkbox"/> Room temperature Comfort setpoint HC1	20.0 °C	22 °C
	<input checked="" type="checkbox"/> Room temp reduced setpoint heat circuit 1	16.0 °C	19 °C
	<input checked="" type="checkbox"/> Summer/winter changeover temp heat circuit 1	20.0 °C	20 °C

5.1.2 LPB/BSB bus topology

The OZW672.01 web server can monitor 1 bus device via the "Energy indicator" function. The OZW672.04 web server can monitor up to 4, and OZW672.16 up to 16 bus devices via the "Energy indicator" function.

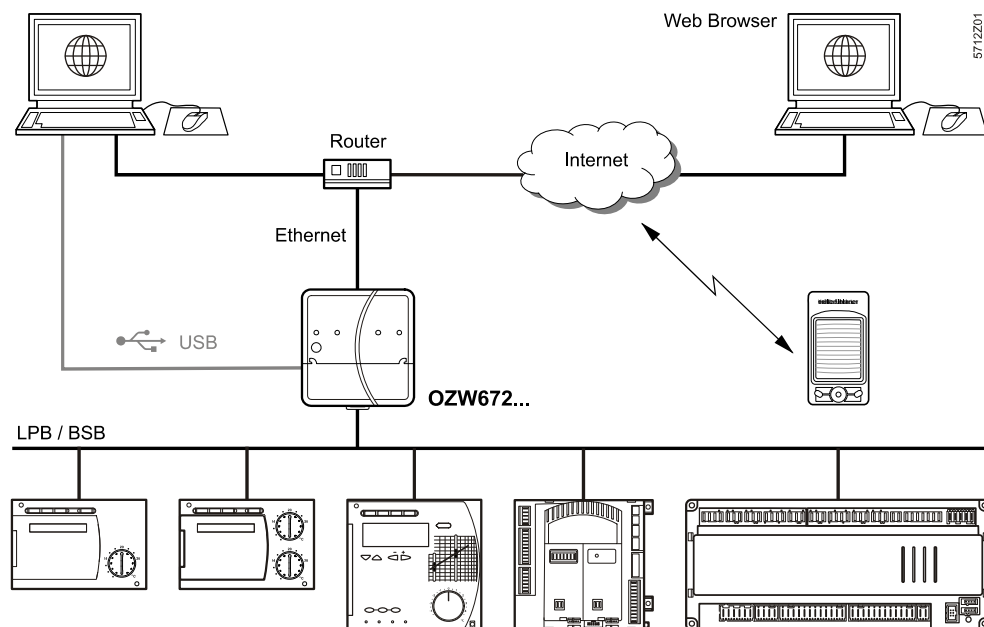

Note

A maximum processing time of ca. 40 minutes results for the max. quantity of "Energy indicator" data points.

5.1.3 LPB/BSB devices

The following devices from the Sigmagr/Albatros product range can be connected to each OZW672... web server via LPB/BSB.

- Heating controllers RVL4..., RVP3..
- District heating controller RVD2..
- Heating controllers RVA..., RVS..., RVC..
- Boiler management units LMU..., LMS..

Device description

The "Energy indicator" data points and "Green limits" have predefined in the "Device description" with device-specific default values. The default values can be changed with a few notable exceptions.

Neither number nor selection of the "Energy indicator" data points and "Green limits" that exist in the "Device description" can be changed.

5.1.4 Navigation and device web pages

Navigation

Go to the "Energy indicator" function as follows:

- Via primary navigation, main function "Energy indicator".
- Click the "Plant state Energy indicator" pane (top right field pane tree leaf in the screenshot below).

Primary navigation

On the web page, you can select the "Energy indicator" function from the primary navigation next to "Home".

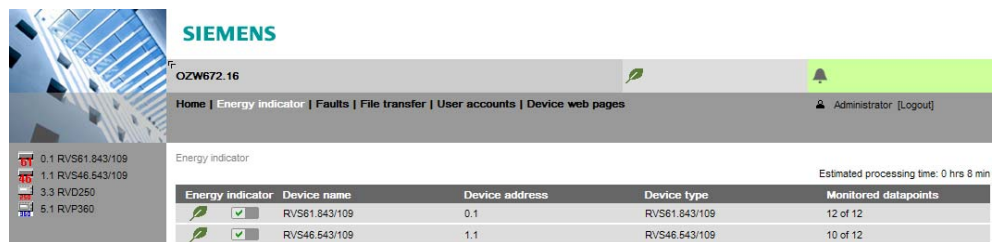

Energy indicator	Device name	Device address	Device type	Monitored datapoints
<input checked="" type="checkbox"/>	RVS61.843/109	0.1	RVS61.843/109	12 of 12
<input checked="" type="checkbox"/>	RVS46.543/109	1.1	RVS46.543/109	10 of 12

Secondary navigation

In secondary navigation, both partial plants and/or devices are displayed sorted by device address in ascending order.

Device web pages state "Generated"

State "Generated" in column "State" in "Device web pages" is a precondition for displaying the devices using the "Energy indicator" function (see Section 2.4).

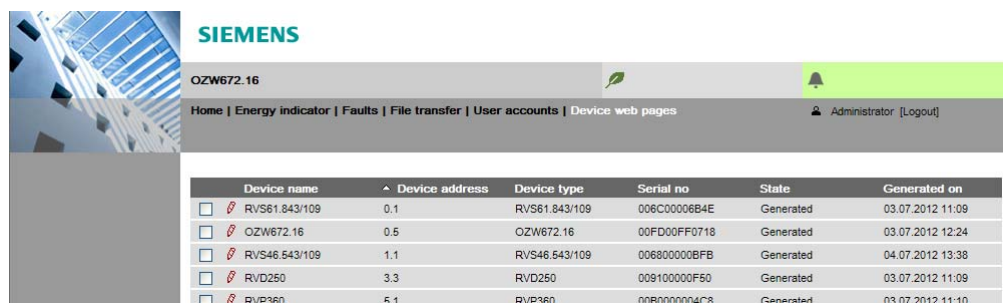

Device name	Device address	Device type	Serial no	State	Generated on
<input type="checkbox"/> RVS61.843/109	0.1	RVS61.843/109	006C00006B4E	Generated	03.07.2012 11:09
<input type="checkbox"/> OZW672.16	0.5	OZW672.16	00FD00FF0718	Generated	03.07.2012 12:24
<input type="checkbox"/> RVS46.543/109	1.1	RVS46.543/109	006800000BFB	Generated	04.07.2012 13:38
<input type="checkbox"/> RVD250	3.3	RVD250	009100000F50	Generated	03.07.2012 11:09
<input type="checkbox"/> RVP360	5.1	RVP360	00B0000004C8	Generated	03.07.2012 11:10

Note

The "Device web pages" (see screenshot) pane can be opened with "Service" and "Administrator" access rights.

5.2 "Energy indicator" function levels

Level designations

The contents of the "Energy indicator" function are distributed across 2 or 3 levels depending on the functionality of the respective device.

- Simple devices have 2 levels:
 1. "Plant"
 2. "Data points"
- Complex devices have 3 levels:
 3. "Plant"
 4. "Partial plants"
 5. "Data points"

5.2.1 "Plant" level

Enter the "Plant" level

Enter the "Plant" level as follows:

- Click the "Energy indicator" function (primary navigation) or
- Click the "Plant state Energy indicator" pane.

The "Plant" level shows all devices of a plant subject to the "Energy indicator" function.

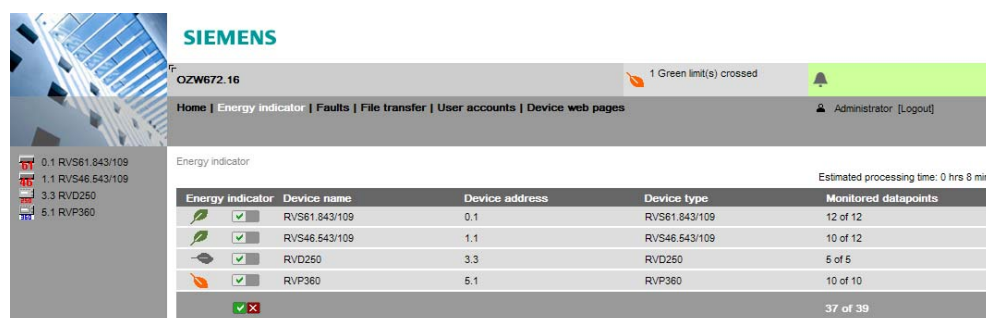

The screenshot shows the Siemens Energy indicator web interface. The top navigation bar includes "Home | Energy indicator | Faults | File transfer | User accounts | Device web pages". The main content area displays a table of devices with the following columns: Energy indicator, Device name, Device address, Device type, and Monitored datapoints. The table contains four rows of device data and a summary row at the bottom.

Energy indicator	Device name	Device address	Device type	Monitored datapoints
	RVS61.843/109	0.1	RVS61.843/109	12 of 12
	RVS46.543/109	1.1	RVS46.543/109	10 of 12
	RVD250	3.3	RVD250	5 of 5
	RVP360	5.1	RVP360	10 of 10
				37 of 39

"Energy indicator" for a plant

The "Energy indicator" of the plant is displayed as a **summary display** in the "Plant state Energy indicator" pane. See Section 5.2.6 for information on the summary display.

"Energy indicator" for devices

The "Energy indicator" for devices is displayed at the "Plant" level in the "Energy indicator" column for each device.

Next lower level

Clicking the name of a device in secondary navigation or in the "Device name" column opens the next lower level for that device.

Table columns

Energy indicator

"Energy indicator" (tree leaf) for each actively monitored device.

This column also contains:

- Checkboxes to activate/deactivate monitoring of the "Energy indicator" data points for the selected device.
- Summary checkbox (green/red) to activate/deactivate monitoring for all data points of the plant.

The summary checkbox is available only for access level "Administrator"; see Section 5.3.4.

When a checkbox is cleared (deactivated), message "Monitoring off, green limits reset to default values! Really to be continued?" is displayed; see Section 5.3.4.

Device name, device type	The device name is displayed if defined (prior to creating the "Device list"), otherwise the device type. The devices are sorted by device address in ascending order.
Device address	Network address (area.line.deviceaddress)
Device type	Device type (technical device designation)
Monitored data points	Indication of the number of actively monitored data points (x) for possible number of data points to be monitored (y) for each device; see Section 5.2.4.
Note	Clicking the column title <ul style="list-style-type: none"> • Device name • Device address • Device type sorts the column contents in the table in ascending or descending order.

5.2.2 "Partial plants" level

"Partial plants" level

The "Partial plants" level shows the partial plants of functionally complex devices (see partial plants below for RVS.. Heating controller).

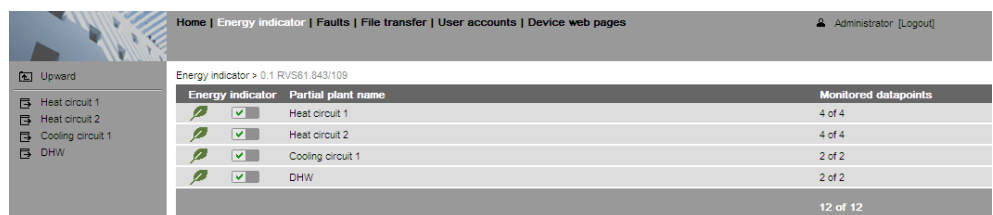

The screenshot shows a web interface for 'Energy indicator > 0.1 RV561.943/109'. It features a secondary navigation menu on the left with options: Upward, Heat circuit 1, Heat circuit 2, Cooling circuit 1, and DHW. The main content area displays a table with the following data:

Energy indicator	Partial plant name	Monitored datapoints
<input checked="" type="checkbox"/>	Heat circuit 1	4 of 4
<input checked="" type="checkbox"/>	Heat circuit 2	4 of 4
<input checked="" type="checkbox"/>	Cooling circuit 1	2 of 2
<input checked="" type="checkbox"/>	DHW	2 of 2
		12 of 12

Next lower level	Clicking the name of a partial plant in secondary navigation or in the "Partial plant name" column opens the next lower level for that partial plant.
Next higher level	Clicking  Upward (in secondary navigation) opens the next higher level.
Table columns	
Energy indicator	"Energy indicator" (tree leaf) for each actively monitored partial plant. This column also contains the checkboxes to activate/deactivate "Energy indicator" monitoring of the data points for the selected partial plant (deactivate without confirmation message).
Partial plant name	Name of the partial plant (taken over by device).
Monitored data points	Indication of the number of actively monitored data points (x) for possible number of data points to be monitored (y) for each partial plant; see Section 5.2.4.

Notes

When level "Partial plants" is selected, they are sorted by "Device description". Users cannot change the sort order.

In functionally complex devices with many data points, they are assigned to the partial plants. The data points of the partial plants (per partial plant) are displayed at the "Data point" level; see below.

The "Partial plants" level is not available in functionally simple devices with few data points.



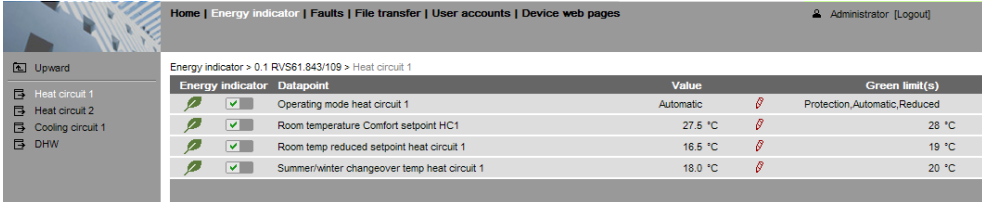

5.2.3 "Data points" level

"Data points" level

The "Data points" level shows the data points to be monitored (see the data points for partial plant "Heat circuit 1" below).



The screenshot shows a web interface with a navigation menu on the left and a main content area. The main content area displays a table of data points for 'Heat circuit 1'. The table has four columns: 'Energy indicator', 'Datapoint', 'Value', and 'Green limit(s)'. Each row represents a different data point with its corresponding value and green limit.

Energy indicator	Datapoint	Value	Green limit(s)
 <input checked="" type="checkbox"/>	Operating mode heat circuit 1	Automatic	Protection, Automatic, Reduced
 <input checked="" type="checkbox"/>	Room temperature Comfort setpoint HC1	27.5 °C	28 °C
 <input checked="" type="checkbox"/>	Room temp reduced setpoint heat circuit 1	16.5 °C	19 °C
 <input checked="" type="checkbox"/>	Summer/winter changeover temp heat circuit 1	18.0 °C	20 °C

Next higher level

Clicking  Upward (in secondary navigation) opens the next higher level.

Table columns

Energy indicator

"Energy indicator" (tree leaf) for each actively monitored data point.

This column also contains the checkboxes to activate/deactivate "Energy indicator" monitoring of the selected data point (deactivate without confirmation message).

Data point

Name of the data point.

Value

Value of the data point (dependent on data point type with unit, e.g. °C).

Symbol  (red pen)

Clicking the red pen  symbol opens the dialog box for the selected data point; see Section 5.4.

Green limit(s)

Value of the set "Green limit" (dependent on data point type and unit).

Enumeration values for "Green leaf" are displayed for "Green limits" with enumeration values such as "Automatic", "Comfort".

Invisible values are replaced by dots "..." if not all enumeration values can be displayed. The dialog box (click red pen symbol ) shows all enumeration values.

Note

When level "Data points" is selected, they are sorted by "Device Description". Users cannot change the sort order.





5.2.4 Number of "Monitored data points"

Column "Monitored data points"

The "Monitored data points" column shows the number of **actively** monitored data points (x) compared to the number of data points (y) that could be monitored.



"Plant" level

"x of y" is displayed for each device and partial plant in the corresponding row. The sum of all devices and partial plants is displayed in the bottom row.

Energy indicator	Device name	Device address	Device type	Monitored datapoints
 <input checked="" type="checkbox"/>	RVS61.843/109	0.1	RVS61.843/109	12 of 12
 <input checked="" type="checkbox"/>	RVS46.643/109	1.1	RVS46.643/109	10 of 12
 <input checked="" type="checkbox"/>	RVD250	3.3	RVD250	5 of 5
 <input checked="" type="checkbox"/>	RVP360	5.1	RVP360	10 of 10
<input checked="" type="checkbox"/> <input checked="" type="checkbox"/>				37 of 39

"Partial plants" level

"x of y" is displayed for each partial plant in the corresponding row and the sum of all partial plants is displayed in the bottom row.

Energy indicator	Partial plant name	Monitored datapoints
 <input checked="" type="checkbox"/>	Heat circuit 1	4 of 4
 <input checked="" type="checkbox"/>	Heat circuit 2	4 of 4
<input checked="" type="checkbox"/> <input checked="" type="checkbox"/>	Cooling circuit 1	0 of 2
 <input checked="" type="checkbox"/>	DHW	2 of 2
		10 of 12

Note

Level "Data points" does not have indication "x of y".

5.2.5 "Energy indicator" visibility

Configuration of visibility

Visibility of the "Energy indicator" symbol is configured at the "Administrator" access level and "Service" in the web server.

Path: OZW672... > Settings > Energy indicator > Energy indicator on the web (very bottom of web page)

The screenshot shows the web interface for configuring the 'Energy indicator' on the web. The breadcrumb path is 'Home > 0.5 OZW672.16 > Settings > Energy indicator'. The main content area displays a table of configuration parameters for two email receivers. An 'Edit' dialog box is open, showing the 'Energy indicator on the web' setting with two radio buttons: 'Not visible' and 'Visible'. The 'Visible' option is selected. The 'OK' and 'Cancel' buttons are visible at the bottom of the dialog.

Datapoint	Value
E-mail receiver 1	
E-mail address	roxana.freusse@siemens.com
Transmit time 1	16:32 h.m
Release transmit time 1	On
Transmit time 2	06:28 h.m
Release transmit time 2	On
Test receiver	---
Energy indicator sent	---
Cause	---
E-mail receiver 2	
E-mail address	roxana.freusse@siemens.com
Transmit time 1	12:29 h.m
Release transmit time 1	On
Transmit time 2	06:15 h.m
Release transmit time 2	On
Test receiver	---
Energy indicator sent	---
Cause	---
Visibility	
Energy indicator on the web	Visible

Notes

"Energy indicator" remains active even if "Energy indicator on the web = Not visible" is selected.

Configuration "Energy indicator on the web" (Visible/Not visible) also applies to user groups "Service" and "End user".

5.2.6 Summary display "Energy indicator" for a plant

Summary display

The "Energy indicator" of the plant OR-links the "Energy indicators" of all devices across all levels. It is displayed as a summary:

- LED ① on the web server (see figure in Section 1.2).
- Web page "Plant" in the "Plant state Energy indicator" pane.

LED ① on web server

The following colors of LED ① on the web server front mean:

- LED is lit green "Energy indicator" of the plant = "Green leaf".
- LED is lit orange "Energy indicator" of the plant = "Orange leaf".

Summary display "Plant" web page



- "Green leaf"
All actively monitored data points of the plant are within limits, i.e. no "Green limits" are violated.
- "Orange leaf"
At least one monitored data point is outside its "Green limit". The number of data points outside their "Green limit" is displayed in addition to the tree leaf.

The summary display "Orange leaf" with "2 Green limit(s) crossed" is displayed (in the previous example) because two "Green limits" were exceeded in "Heat circuit 2" (see next screenshot).

Energy indicator	Datapoint	Value	Green limit(s)
	Operating mode heat circuit 2	Protection	Protection, Automatic, Reduced
	Room temperature Comfort setpoint HC2	25.5 °C	22 °C
	Room temp reduced setpoint heat circuit 2	24.0 °C	19 °C
	Summer/winter changeover temp heat circuit 2	18.0 °C	20.5 °C

5.3 "Energy indicator" commissioning function

5.3.1 Commissioning notes

Prerequisites

Prerequisites for commissioning the "Energy indicator" function:

- Login with **"Administrator" access right**.
- Generating the devices in the web server. This generates the "Energy indicator" data points for each device.
- Devices on the Device web pages must have state "Generated".

Device web pages

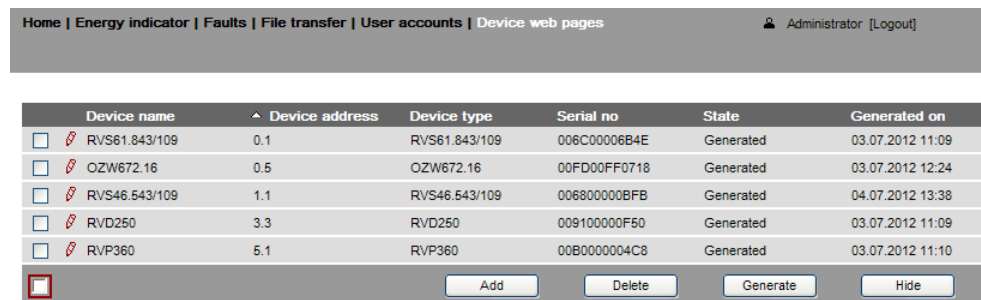

The screenshot shows a web interface with a navigation bar at the top containing links: Home | Energy indicator | Faults | File transfer | User accounts | Device web pages. The user is logged in as Administrator. Below the navigation bar is a table with the following columns: Device name, Device address, Device type, Serial no, State, and Generated on. The table contains five rows of device data. At the bottom of the table are four buttons: Add, Delete, Generate, and Hide.

Device name	Device address	Device type	Serial no	State	Generated on
<input type="checkbox"/> RVS61.843/109	0.1	RVS61.843/109	006C00006B4E	Generated	03.07.2012 11:09
<input type="checkbox"/> OZW672.16	0.5	OZW672.16	00FD00FF0718	Generated	03.07.2012 12:24
<input type="checkbox"/> RVS46.543/109	1.1	RVS46.543/109	006800000BFB	Generated	04.07.2012 13:38
<input type="checkbox"/> RVD250	3.3	RVD250	009100000F60	Generated	03.07.2012 11:09
<input type="checkbox"/> RVP360	5.1	RVP360	00B0000004C8	Generated	03.07.2012 11:10

5.3.2 Start "Energy indicator" function

Start "Energy indicator" function

The "Energy indicator" function in the OZW672... web server is started automatically if the above prerequisites are fulfilled.

Notes

The devices must contain at least one "Energy indicator" data point to be displayed as part of the "Energy indicator" function.

The "Energy indicator" database only exists on the web server. And the web server itself has no data points subject to the "Energy indicator" function.

Temporary status

"---" is temporarily displayed for a data point's status in the "Value" column until the data point value is read and processed via the bus.

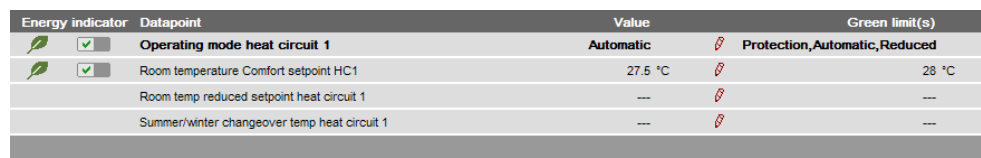

The screenshot shows a table with the following columns: Energy indicator, Datapoint, Value, and Green limit(s). The table contains four rows of data. The first row has a green leaf icon and a checked checkbox. The second row has a green leaf icon and a checked checkbox. The third and fourth rows have a grey leaf icon and an unchecked checkbox.

Energy indicator	Datapoint	Value	Green limit(s)
	<input checked="" type="checkbox"/> Operating mode heat circuit 1	Automatic	Protection, Automatic, Reduced
	<input checked="" type="checkbox"/> Room temperature Comfort setpoint HC1	27.5 °C	28 °C
	<input type="checkbox"/> Room temp reduced setpoint heat circuit 1	---	---
	<input type="checkbox"/> Summer/winter changeover temp heat circuit 1	---	---

Updates on the web page

A maximum of 4 "Energy indicators" per second are updated on a web page. The actual number depends on effective bus load. In the event of concurrent user access, bandwidth is distributed across all users.

Note

Device data point values are not transmitted if there is no bus supply or if the LPB/BSB bus is interrupted.

No comparison to "Green limits" then takes place and column "Value" contains "---" while column "Energy indicator" displays a "Grey leaf".

5.3.3 Estimated processing time







After starting the "Energy indicator" function, the "Plant" web page contains the following:

- Summary display "Energy indicator"; see Section 5.2.6.
- Number of monitored data points; see Section 5.2.4.
- "Estimated processing time"; see below.

Estimated processing time

The "Estimated processing time" is displayed in hours and minutes.

Energy indicator Estimated processing time: 0 hrs 8 min

Energy indicator	Device name	Device address	Device type	Monitored datapoints
 <input checked="" type="checkbox"/>	RVS61.843/109	0.1	RVS61.843/109	12 of 12
 <input checked="" type="checkbox"/>	RVS43.143/109	1.1	RVS43.143/109	8 of 8
 <input checked="" type="checkbox"/>	RVP360	10.10	RVP360	10 of 10
 <input checked="" type="checkbox"/>	RVD260	13.13	RVD260	8 of 8
 <input checked="" type="checkbox"/> 				38 of 38

Processing time at base load

When monitoring is active, the web server first reads each data point from the bus devices and then compares the values to its "Green limit".

Processing time at base load per data point is 12 seconds (longer if the bus carries a heavy load).

Updated display for "Energy indicator"

Thus, updating the "Energy indicator" (leaf color) display may take up to 40 minutes. Therefore:

- "Green leaf" (start-up mode)
The "Green leaf" display does not necessarily reflect the current plant state prior to completion of the "Estimated processing time".
- The updated display of "Energy indicator" can be postponed by max. the "Estimated processing time".

Note

Note the restriction from the "updated "Energy indicator" display" also when navigating to other web pages.

5.3.4 Deactivating "Data point monitoring"

Deactivation

Monitoring "Energy indicator" data points is activated automatically following device list creation.

Thus, data point monitoring can only be deactivated as a first step.

- Deactivation for "Data point monitoring" requires "Administrator" access rights.

The checkbox in the "Energy indicator" column allows for deactivating monitoring of one or multiple data points e.g. for operational reasons.

- Data point monitoring active (default following commissioning)
-  Data point monitoring deactivated

"Plant" level
Selecting the checkbox deactivates the data points for the selected device (can be reactivated).
Selecting the summary checkbox (green/red, bottom row) deactivates the data points for the plant (can be reactivated)).



Note
A **confirmation message** is displayed when data point monitoring for a device or plant is deactivated; see below.

"Partial plants" level
Selecting the checkbox deactivates the data points for the selected partial plant (can be reactivated)).
No confirmation message is displayed when data point monitoring for a partial plant is deactivated.

"Data points" level
Selecting the checkbox deactivates the selected data point (can be reactivated)).
No confirmation message is displayed when data point monitoring is deactivated.

Confirmation message for "Monitoring off"
A confirmation message is displayed when data point monitoring for a device or plant is deactivated:

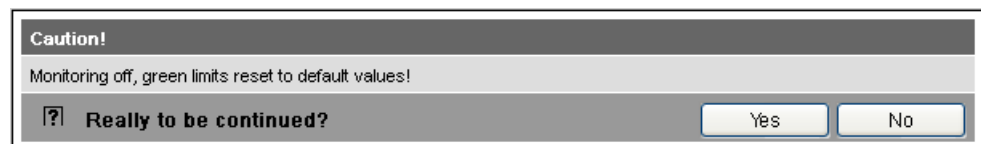

Green limits to default values!
Clicking [Yes] for message "Really to be continued?" to deactivate monitoring also resets "Green limits" (changed by the user) to their default values. Therefore:
"Monitoring off" deactivates monitoring while, at the same time, setting the "Green limits" to the default values of device list creation.

Note
Contrary to the "Green limits", deactivation does **not** reset changed data point values to default values. Therefore:
Following "Monitoring off" and reactivation, "Energy indicator" data points may no longer be within the green limits, as the "Green limits" reset to default values have different dependencies.

5.3.5 Activating "Data point monitoring"

Activation

Monitoring "Energy indicator" data points is activated automatically following device list creation.

Data point monitoring can thus be activated only following deactivation; see Section 5.3.4.

- Activation for "Data point monitoring" requires "Administrator" access rights.

The checkbox in the "Energy indicator" column allows for activating monitoring of one or multiple data points e.g. following temporary deactivation.



Data point monitoring deactivated (by user)



Data point monitoring activated

"Plant" level

Selecting the checkbox activates the data points for the selected device.

Selecting the summary checkbox (green/red, bottom row) activates the data points for the plant.

"Partial plants" level

Selecting the checkbox activates the data points for the selected partial plant.

Example

Monitoring is deactivated for partial plant "Cooling circuit 1". As a result, all data points are deactivated.

"Cooling circuit 1" is deactivated.

Energy indicator	Partial plant name
<input checked="" type="checkbox"/>	Heat circuit 1
<input checked="" type="checkbox"/>	Heat circuit 2
<input type="checkbox"/>	Cooling circuit 1

"Monitored data points" 0 of 2.

Monitored datapoints
4 of 4
4 of 4
0 of 2

Data points "Cooling circuit 1" are deactivated.

Energy indicator	Datapoint
<input type="checkbox"/>	Release cooling circuit 1
<input type="checkbox"/>	Room temp Comfort setpoint cooling circuit 1

Selecting the checkbox for partial plant "Cooling circuit 1" activates it. As a result, all data points at the "Data points" level are also activated.

"Cooling circuit 1" is reactivated.

Energy indicator	Partial plant name
<input checked="" type="checkbox"/>	Heat circuit 1
<input checked="" type="checkbox"/>	Heat circuit 2
<input checked="" type="checkbox"/>	Cooling circuit 1

All data points of "Cooling circuit 1" are reactivated.

Energy indicator	Datapoint
<input checked="" type="checkbox"/>	Release cooling circuit 1
<input checked="" type="checkbox"/>	Room temp Comfort setpoint cooling circuit 1

"Data points" level

Selecting the checkbox activates the selected data point.



Example

Starting point: All data points of partial plant "Cooling circuit 1" are deactivated.
Activating just one data point also activates the partial plant.

A data point (Release cooling circuit 1) of partial plant "Cooling circuit 1" is activated.

Energy indicator	Datapoint
	<input checked="" type="checkbox"/> Release cooling circuit 1
	<input type="checkbox"/> Room temp Comfort setpoint cooling circuit 1

Partial plant "Cooling circuit 1" is automatically activated.

Energy indicator	Partial plant name
	<input checked="" type="checkbox"/> Heat circuit 1
	<input checked="" type="checkbox"/> Heat circuit 2
	<input checked="" type="checkbox"/> Cooling circuit 1

Note

Note that "Monitoring activated" at the "Partial plants" level does not mean that **all** subordinate data points are activated and monitored also. This also applies to "Monitoring activated" at the "Plant level".

5.4 Dialog boxes, data points, and "Green limits"

5.4.1 General dialog boxes

Open a dialog box

Clicking the red pen  symbol opens the dialog box for the selected data point. This allows you to either change the data point value and/or the "Green limit".

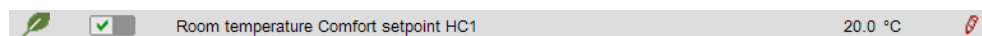

Dialog box

Room temperature Comfort setpoint HC1

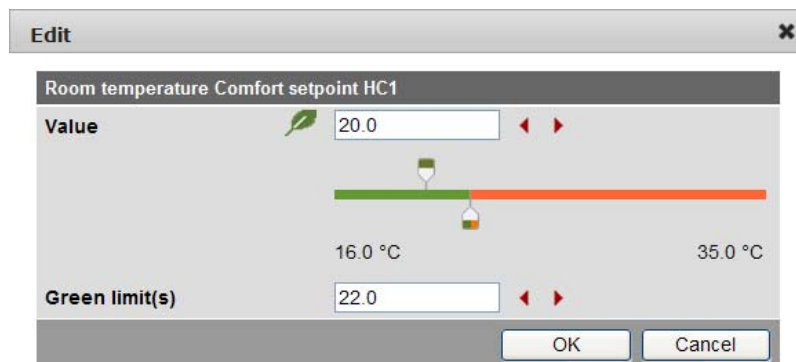

Contents



The dialog box contains the following information:

- Name (data point)
- Value (data point)
- "Energy indicator" as:
 - "Green leaf" Green tree leaf
 - or
 - "Orange leaf" Orange tree leaf
- "Green limit(s)"
- Setting range 16.0 °C to 35.0 °C for data point and "Green limit(s)"

Value

Data point value

The set data point value is displayed in the field above the setting range. There are 3 ways to change the data point value:

- Change the data point value in the entry field.
- Move the data point slider to the right or left.
- Arrows   to adjust the value step by step.

The data point slider is green for as long as the data point value is within the green setting range (up to and including "Green limit"). If the data point value is moved to the orange range, the slider turns orange.

Setting range

Bars

The setting range for the data point value and its "Green limit" corresponds to the green/orange bar limited by value indications to the right and left of the bar.

Green limit(s)

Each data point monitored with the "Energy indicator" function has its own "Green limit". There are 3 ways to change the "Green limit":

- Change the value for the "Green limit(s)" in the entry field.
- Move the "Green limit(s)" slider to the right or left.
- Arrows ◀ ▶ to adjust the value step by step.

The "Green limit" slider is always "green/orange". If the slider is moved to the setting range limit value, the bar color disappears in the direction of the movement.

Notes

The default values defined for data point and "Green limit(s)" in the "Device description" are displayed in the corresponding entry field.

After values are changed (by the user), default values can be regenerated only by deactivating "Data point monitoring" (with summary checkbox).

5.4.2 Dialog boxes with numeric data points

In numeric data points such as "Room temperature Comfort setpoint HC1", the "Green limits" may depend on neighboring values. Therefore:

To achieve the desired setting range, the data points (heating circuit and cooling circuit setpoints) and their "Green limits" must be set in relation to the neighboring value.

Note

Dependency of neighboring values always depends on the data point values (setpoints), not the "Green limits".

Room temperature Comfort setpoint HC1

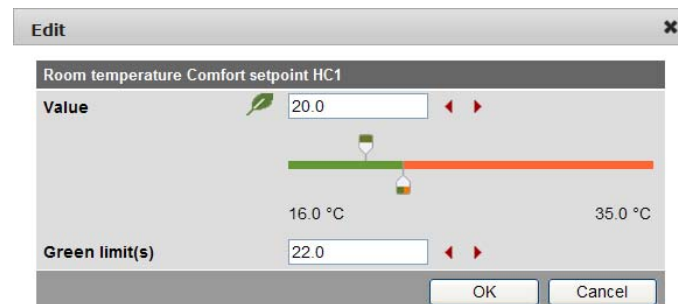

Note

Set the heating setpoint by 1 K lower (or max. the same) as the "Green limit" to display the "Energy indicator" = "Green leaf".

Room temp Comfort setpoint cooling circuit 1

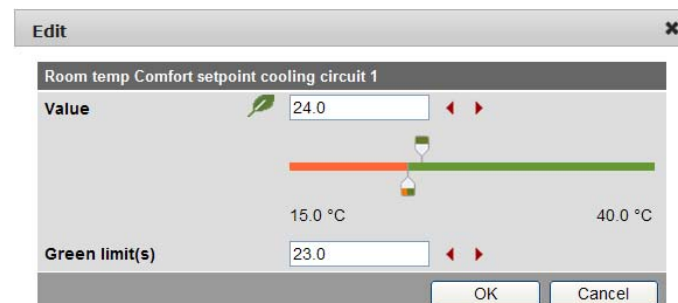

Note

Set the cooling setpoint by 1 K higher (or max. the same) as the "Green limit" to display the "Energy indicator" = "Green leaf".

Room temp setpoint readjustment HC2

In the "Room temp readjustment setpoint HC2" dialog box, the data point value corresponds to the adjustment range, symmetrical to the zero-point axis. This requires 2 "Green limits".

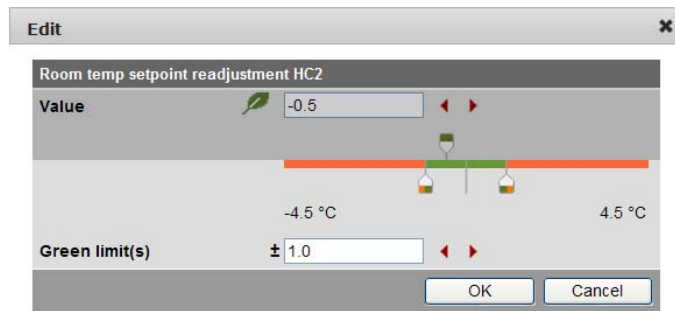

5.4.3 Dialog boxes with enumeration data points

A dialog box with enumeration values, at least one "Green limit" for a value to be monitored needs to be set.

Operating mode heat circuit 1

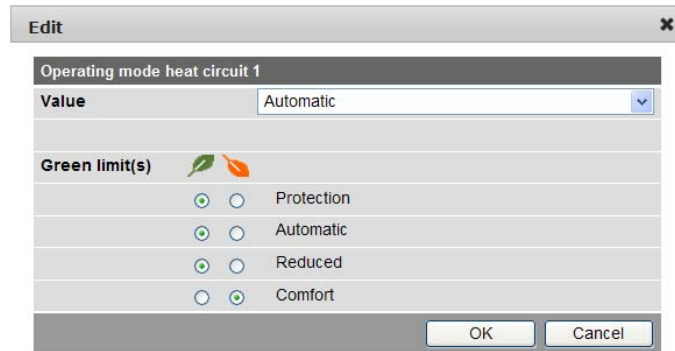

Note

The enumeration values are predefined as per the data point type. The "Green limit(s)" are set by clicking the selection boxes.

5.4.4 User groups "Service" and "End user"

The dialog boxes for the "Energy indicator" data points can be opened also in the "Service" and "End user" user groups.

The entry fields of values that can not be set are grayed, i.e. they are unavailable for editing. Other than that, the dialog boxes are the same as for the "Administrator" user group.

5.5 E-mail with "Energy indicator" for the plant

5.5.1 E-mail receiver configuration

Either **no** E-mail (no transmit time = Default) or one or two e-mails (Transmit time 1 and/or Transmit time 2) can be sent with the plant's "Energy indicator".

E-mail receiver configuration

E-mail receivers 1 and 2 can be configured with "Administrator" and "Service" access rights on the web server.

Path: OZW672... > Settings > Energy indicator

The screenshot shows a web interface with a navigation menu on the left and a configuration table on the right. The breadcrumb path is 'Home > 0.5 OZW672.16 > Settings > Energy indicator'. The table has two columns: 'Datapoint' and 'Value'. It is divided into sections for 'E-mail receiver 1' and 'E-mail receiver 2', and a 'Visibility' section at the bottom.

Datapoint	Value
E-mail receiver 1	
E-mail address	roxana.freusse@siemens.com
Transmit time 1	16:01 h.m
Release transmit time 1	Off
Transmit time 2	06:28 h.m
Release transmit time 2	Off
Test receiver	---
Energy indicator sent	---
Cause	---
E-mail receiver 2	
E-mail address	roxana.freusse@siemens.com
Transmit time 1	12:29 h.m
Release transmit time 1	Off
Transmit time 2	06:15 h.m
Release transmit time 2	Off
Test receiver	---
Energy indicator sent	---
Cause	---
Visibility	
Energy indicator on the web	Visible

Notes

E-mail receivers 1 and 2 are configured individually (separate settings).

If Transmit time 1 and/or 2 are configured, the "Energy indicator" of the plant is sent as an e-mail **only** if at least one monitored data point exceeds its "Green limit".

Configuration of e-mail receivers 1 and 2 for the "Energy indicator" of the plant is not related to the e-mail receivers of fault messages (device failure etc.).

Test receiver

One e-mail each can be sent for test purposes to E-mail receiver 1 and 2.

- The test is triggered manually via data point "Test receiver = Trigger".
- Reception is confirmed in data point "Energy indicator transmitted = Yes".
- Data point "Reason" contains feedback on whether the e-mail was sent or which setting must be checked in the event of an error.

"Energy indicator transmitted" and "Reason"

The values of the data points "Energy indicator transmitted" and "Reason" are displayed after testing until:

- Another test is triggered manually.
- The next transmitted e-mail is transmitted as per Transmit time 1 and/or 2.
- The device supply is switched on and off.

Data point	Function
Test receiver	[---, trigger]
"Energy indicator transmitted"	[---, Yes, No]
Reason	[---, DNS setting, mail server address, mail server port number, e-mail address recipient, mail server authentication, network cable]

Note

Manual triggering for test purposes does not trigger a fault message.

Fault message e-mail

If an e-mail with "Energy indicator" of the plant is not transmitted without error, a fault message is triggered for the corresponding e-mail recipient.

Reset fault message

The fault message is reset if:

- The next transmitted e-mail is transmitted as per Transmit time 1 and/or 2.
- Manually triggered "Test receiver" is successful.

Note

The diagnostic options are identical to those of other e-mail recipients.

5.5.2 Mail inbox

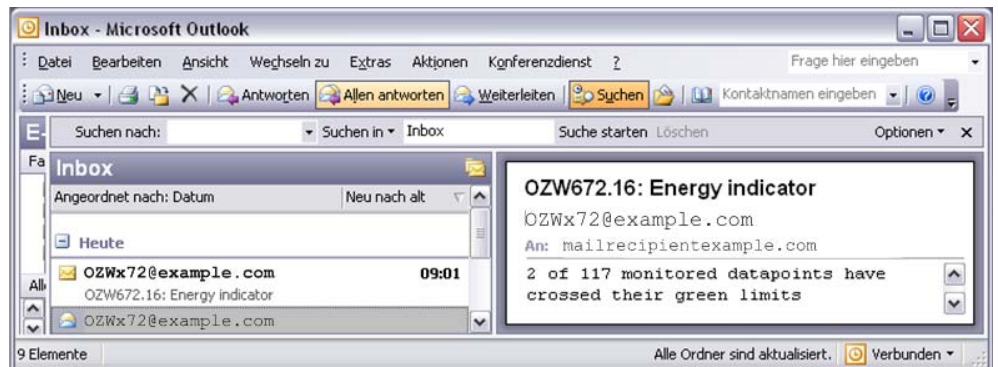

5.5.3 E-mail contents

E-mail Energy indicator contents

The contents of the e-mails comprises (see screenshot below):

- E-mail format Text only (see message field below).
- E-mail sender As per the settings (e.g. ozw672@example.com).
- E-mail recipient As per the settings (e.g. first.name.lastname@example.com).

Reference field

The Reference field comprises the following information:

- Plant name: OZW type or user-defined name (see examples).
- Energy indicator Fixed text (e.g. "Energy indicator" translated into the language selected in the web server).

Examples

OZW672.16: Energy indicator

Landmatt 1: Energy indicator

Message field

The actual message is written in the language selected in the web server.

Example

2 of 117 monitored data points have crossed their Green limits.

10 lines follow this text where each line may contain a free text regardless of the language selected in the web server. (Signature line 1...10, with max. 49 characters per line).

E-mail "Energy indicator"

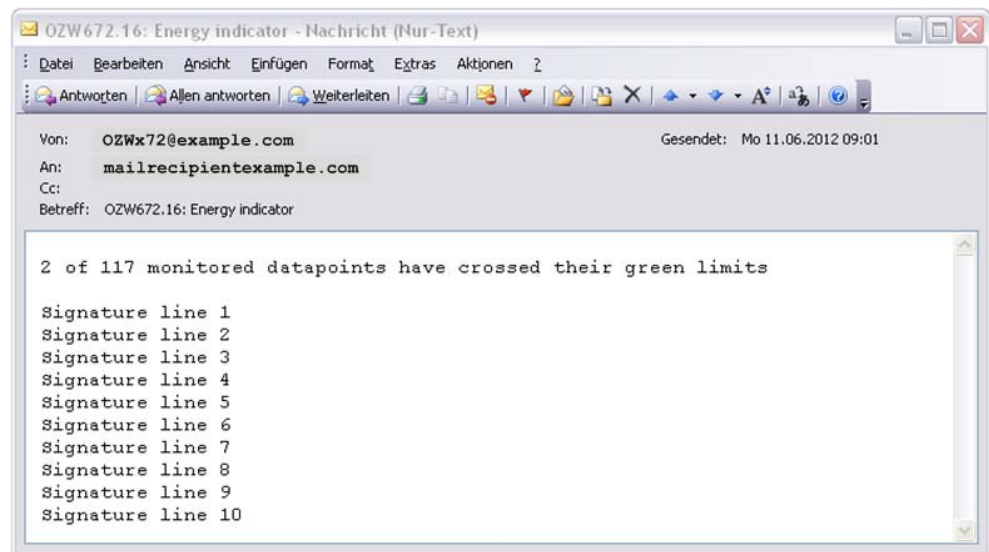

5.6 Exceptions

Regenerate bus devices

The following applies to the "Energy indicator" function when regenerating bus devices:

- Existing data points and their "Green limits" as well as the set status for "Data point monitoring activated/deactivate" remain as is.
- Data points no longer available and their "Green limits" are deleted from the "Energy indicator" database.
- New data points and their "Green limits" are taken over into the "Energy indicator" database and data point monitoring is activated.

Bus devices

Hide

Hiding bus devices is the same as deactivating monitoring. Thus, "Energy indicators" are not calculated and displayed.

Home | Energy indicator | Faults | File transfer | User accounts | Device web pages

Device name	Device address	Device type	Serial no	State	Generated on
<input type="checkbox"/> RVS61.843/109	0.1	RVS61.843/109	006C00006B4E	Generated	03.07.2012 11:09
<input type="checkbox"/> OZW672.16	0.5	OZW672.16	00FD00FF0718	Generated	03.07.2012 12:24
<input type="checkbox"/> RVS46.543/109	1.1	RVS46.543/109	006800000BFB	Generated	04.07.2012 13:38
<input type="checkbox"/> RVD250	3.3	RVD250	009100000F50	Generated	03.07.2012 11:09
<input type="checkbox"/> RVP360	5.1	RVP360	00B0000004C8	Generated	03.07.2012 11:10

Add Delete Generate Hide

Generate again

Bus devices are shown again via "Generate".

Change configuration

Complete changes to the configuration via "Generate".

Replace

Complete bus device replacements via "Generate".

Delete

When deleting bus devices from the device list, the "Energy indicator" data is deleted also.

Special cases

Bus device failure

In the event of bus device failure, e.g. no communication via LPB/BSB bus, the "Grey leaf" is displayed. The "Estimated processing time" does not change.

Missing bus supply

If there is no bus supply, the data point values of the bus devices cannot be read and a "Grey leaf" is displayed. The "Estimated processing time" does not change.

System data update

Complete system data updates for all bus devices via "Generate". "Generate" does not lead to data loss.

Firmware update

In the event of a firmware update, the entire configuration is lost, i.e. parameter set and data for the "Energy indicator" function.

Read and write of the parameter set via ACS790 allow for retaining the configuration of the OZW672 (device list and "Device Descriptions").

Changed data of the "Energy indicator" function are lost. The "Energy indicator" function starts with the data point values and "Green limits" similar to creating a device list in the web server.

Empty page

6 Communications

6.1 Remote operation

The web server can be operated from a PC with web browser on a local area network (LAN) or via the Internet. The following settings also apply to access via Smartphone and other apps via Web API.

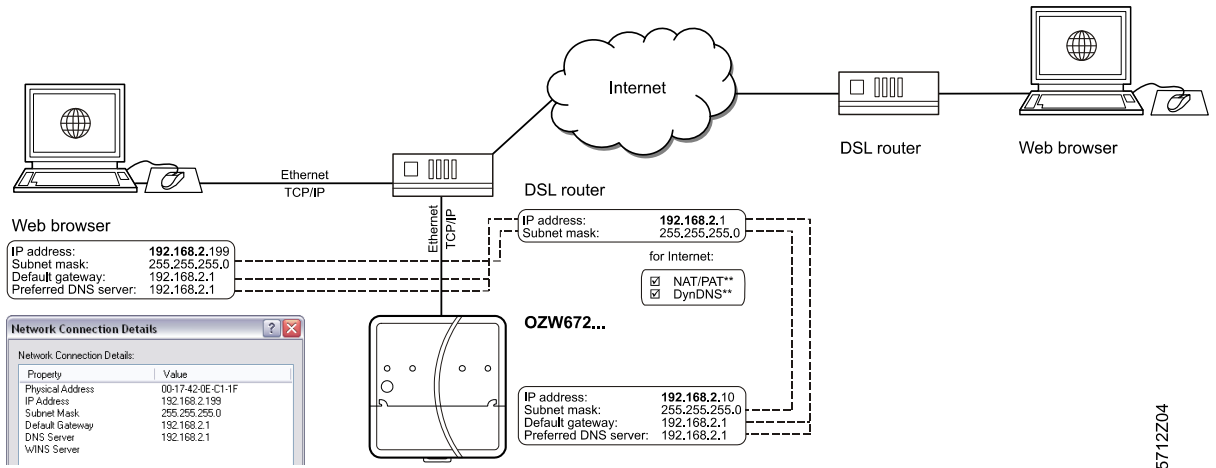

5712Z04

6.1.1 Local area network (LAN)

The PC and web server must be on the same IP subnet to communicate. You must first determine the subnet as well as the IP addresses.

Local area network (with router)

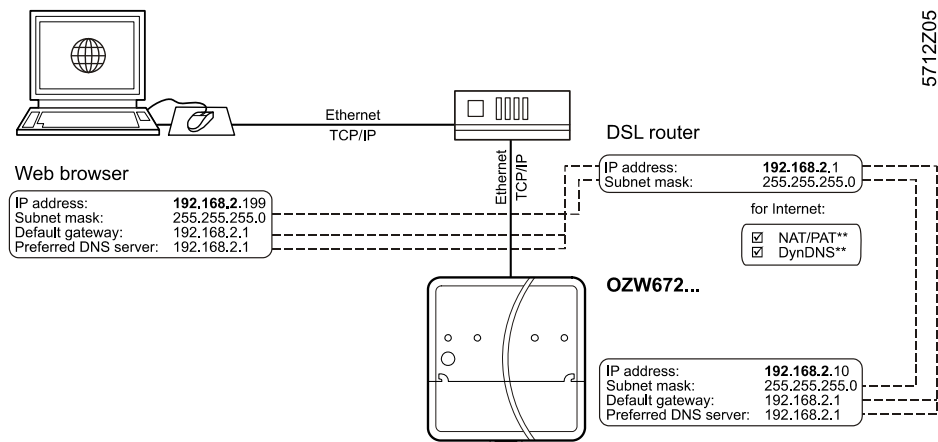

5712Z05

A router normally serves as the DHCP server if installed on a local area network (e.g. DSL router for Internet access). As such, it automatically assigns IP addresses to all participants that are DHCP clients.

If a PC is connected to the router via Ethernet, an IP address, subnet mask, standard gateway and DNS server are assigned automatically.

When delivered, the web server already contains an enabled DHCP client; as a result, users do not need to enter Ethernet settings.

The connection is checked every 3 minutes. It is recommended to assign the IP address of the web server in the router according to its MAC address.

If the router with DHCP server is not available, the web server uses the default IP address 192.168.2.10.

For manual settings, use the PC to determine the required data.

Procedure:

1. Select *Start > Control Panel > Network Connections > Local Area Connection*
2. Select "Support" tab.

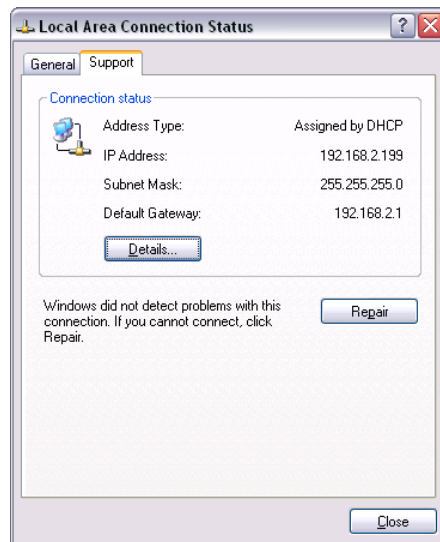

3. Click [Details...]

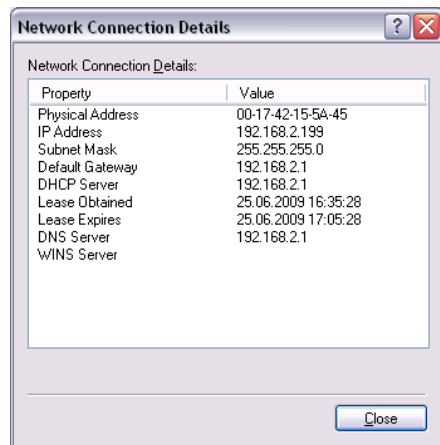

In the example, the PC is assigned the IP address [192.168.2.199](#) and subnet mask [255.255.255.0](#). The default gateway and DNS server have IP address [192.168.2.1](#).

You can use the data to set the web server:

- IP address: Unused address on the subnet. For example [192.168.2.10](#) is still available if the PC uses [192.168.2.199](#) and the router uses [192.168.2.1](#).
- Subnet mask: [255.255.255.0](#)
- Default gateway: [192.168.2.1](#)
- Preferred DNS server: [192.168.2.1](#)
- Alternate DNS server (empty).

Notes



- In the example, the subnet has an address of [192.168.2.x](#). Devices must have the same subnet address to communicate directly (i.e. without a router).
- The web server is delivered as preconfigured DHCP client with automatic reception of the network configuration.
The web server's IP address can be set manually as an option.
- We recommend using IP addresses from the private range in the home network (see Section 7.3.1).

Local area network without router

IP addresses and subnet masks must be entered manually if a local area network is installed with PC and web server, but without a router.

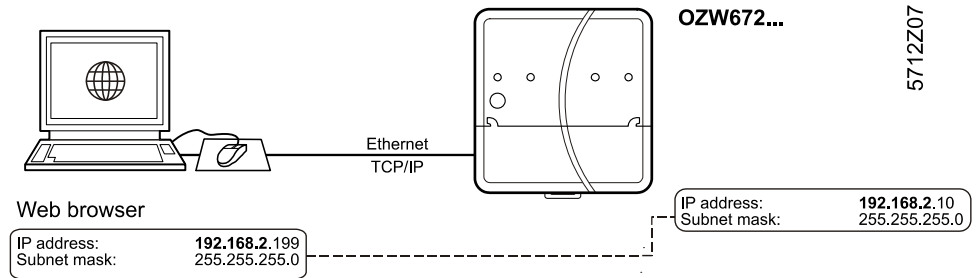

On the PC, set as follows:

1. Select *Start > Control Panel > Network Connections > Local Area Connection*
2. Select the "General" tab.

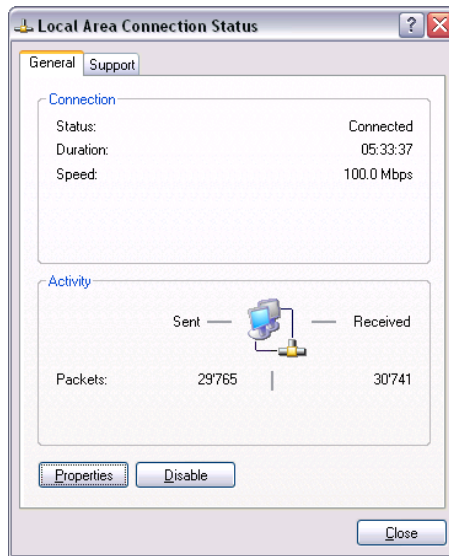

3. Click [Properties]

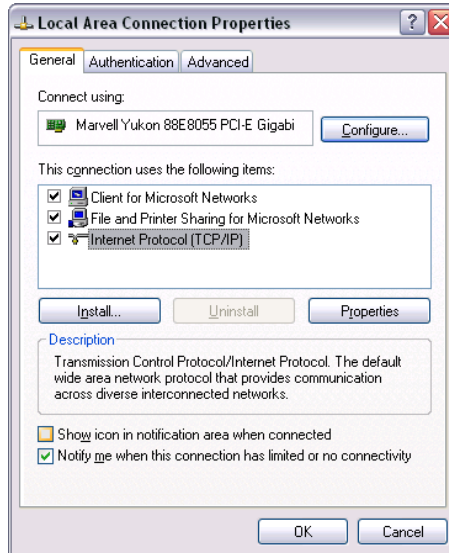

4. Select "Internet Protocol (TCP/IP)".
5. Click [Properties]
6. Select "Use the following IP address".

Continued on next page.

7. Enter the IP address and subnet mask.

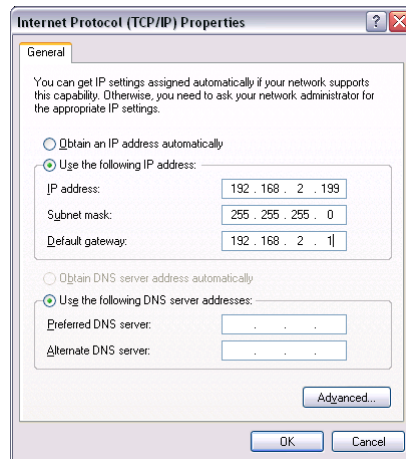

8. Click [OK]

In the example, the PC is assigned IP address [192.168.2.199](#) and subnet mask [255.255.255.0](#)

You can now set the web server:

- IP address: An unused address in subnet, e.g. [192.168.2.10](#)
- Subnet mask: [255.255.255.0](#)
- Default gateway(empty).
- Preferred DNS server(empty).
- Alternate DNS server(empty).

Notes



- In the example, the subnet has an address of [192.168.2.x](#). Devices must have the same subnet address to communicate directly (i.e. without a router).
- The default gateway and DNS server settings have no meaning for LANs without router, provided no e-mail is sent within the home network.
- We recommend using IP addresses from the private range in the home network (see Section 7.3.1).

6.1.2 Remote operation via the Internet

Internet connection

The appropriate connection is required (e.g. DSL router) for remote operation via Internet. Setting up Internet access is not described here.

Notes



- The example here were created using the Siemens Gigaset SX763 router (see Section 7.3.5). Workflow, terms and functionality may differ when using other products.
- The router must support NAT/PAT, DynDNS and DHCP as an option.
- The web server supports HTTPS (Hyper Text Transfer Protocol Secure). Web operating pages are transmitted secured and encrypted.

Local area network (LAN)

IP address, subnet mask and DHCP are set up under Local Network in addition to other settings:

- The IP address router is fixed.
- The subnet mask defines the size of the subnet.
- The router assigns the DHCP clients (e.g. the PC on the local area network) an IP address from a selecting setting range ("First issued IP address" through "Last issued IP address") if set as DHCP server.
- The "Default gateway" is typically the router's IP address as well.
- The "Lease time" defines how long a client maintains the IP address received from the DHCP server (the DHCP server regularly renews the client IP addresses).

Gigaset SX763 WLAN dsl

SIEMENS

In the example, the router has a set IP address of [192.168.2.1](#) and receives subnet mask [255.255.255.0](#). As a DHCP server, it renews the IP addresses of the DHCP clients every 30 (in the above example) minutes. DHCP clients are assigned addresses from a range of [192.168.2.100](#) through [192.168.2.199](#). The router is the gateway between LAN and Internet.

Firewall

We recommend enabling the firewall to protect the local area network:

- Firewall: On.

Gigaset SX763 WLAN dsl

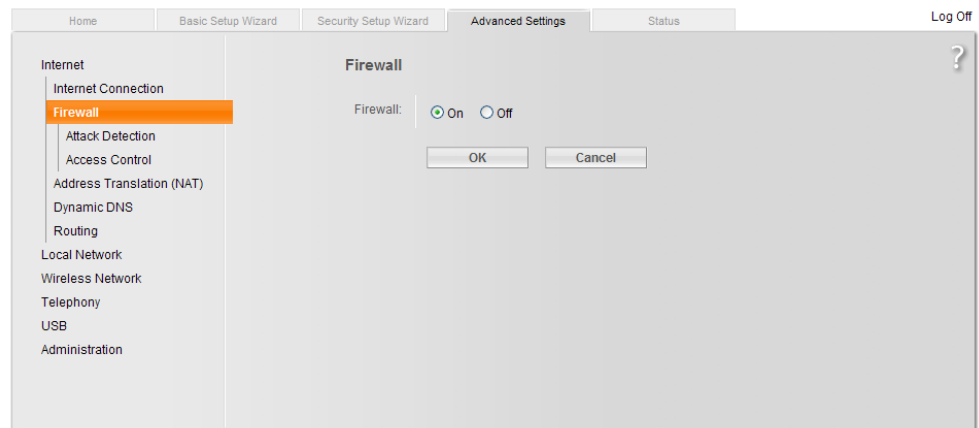

SIEMENS

Address Translation (NAT)

Activate NAT to ensure that the web server can be reached via the Internet.

- NAT: On.

Gigaset SX763 WLAN dsl

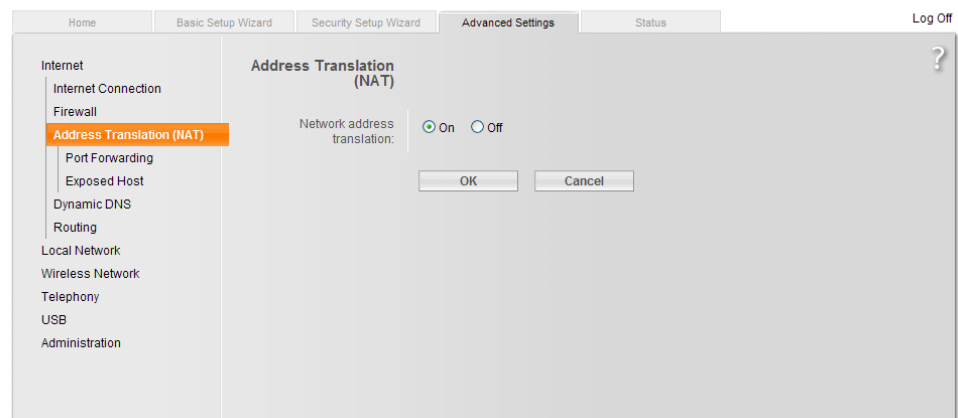

SIEMENS

Port Forwarding (PAT)

- Port Forwarding is used to determine which local IP addresses/ports the router translates to which public IP addresses/ports.
- Web operating pages are preset on the web server via Port 80 (HTTP) or port 443 (HTTPS). As a result, queries from the Internet must be translated using the public IP address/port to the private IP address/port 80 or 443 for the web server.
- When using PC software ACS790 for remote operation, you must also change Port 21 (FTP) and Port 50005 (ACS private) from the public to a private IP address.

Notes



- The port IP address is appended to the web browser address line: <IP address>:<Port>, e.g. 122.104.2.10:80.
- The web browser always uses port 80 unless another port is entered. As a result, the information in the address line for the web browser is always: <IP address>:80 and <IP address>, or 122.104.2.10:80 and 122.104.2.10.
- Ports not equal to 80 are considered more robust against hackers.
- We recommend using Port Forward Ports from the private range.

Protocol	Public port	Local port	Local IP address	Comment	Enabled
TCP	80	80	192 . 168 . 2 . 10	Web-Server	<input checked="" type="checkbox"/>
Predefined applications:	FTP			FTP	<input type="checkbox"/>

SIEMENS

In the example, queries from the Internet to the public IP address (Internet connection)/Port 80 is forwarded to the local IP address 192.168.2.10 (web server) / Port 80.

DynDNS

The web server can communicate directly with the fixed IP address or domain if a fixed IP address or domain (e.g. www.myname.com) is available for the Internet connection.

Dynamic IP address

For dynamic IP addresses, the Internet provides free-of-charge DynDNS services that connect user-defined domain names to dynamic IP addresses. The router must support DynDNS to use this function.

Registration

To use the DynDNS service, a new account must be set up at the respective provider.

Report dynamic address

The router must inform the service of changes to the dynamic IP address for the web server to communicate via the DynDNS service setup. Set up the router DynDNS as follows:

- Dynamic DNS: On
- Service provider: Service provider.
- Domain name: Domain = Host name (own name).
- User name: User name for the DynDNS account (e.g. MyUserAccount).
- Password: Password for DynDNS account.

Gigaset SX763 WLAN dsl

The screenshot shows the 'Advanced Settings' tab of the router's web interface. The 'Dynamic DNS' section is active, with the following configuration:

- Dynamic DNS: On Off
- Service provider: DynDNS.org
- Domain name: myhome.dyndns.info
- User name: MyUserAccount
- Password: [Masked]

Buttons for 'OK' and 'Cancel' are located at the bottom of the configuration area.

SIEMENS

Encrypted connection (HTTPS)

HTTPS encryption via port 443 is also supported. The required certificate is not accredited. The self-signed certificate from Siemens is valid for 20 years and is installed on the web server. The certificate must be installed on the web browser for encrypted communications.

Note



One own certificate must be installed for each web server.

Principal workflow

The web browser security warning is displayed the first time you connect via the <https> address. The page continues to load contrary to the web browser recommendation.

The certificate must now be installed: A context-sensitive installation routine is available depending on web browser used.

Note



The warning "Certificate error" remains for individual web browsers even after the certificate is successfully installed. Transmission is nevertheless secure.

6.2 Messages via e-mail

E-mail

SMTP is used to send fault messages and system reports via email. The mail server (SMTP server, out-going mail server) must be known to the web server to send e-mails to the receivers.

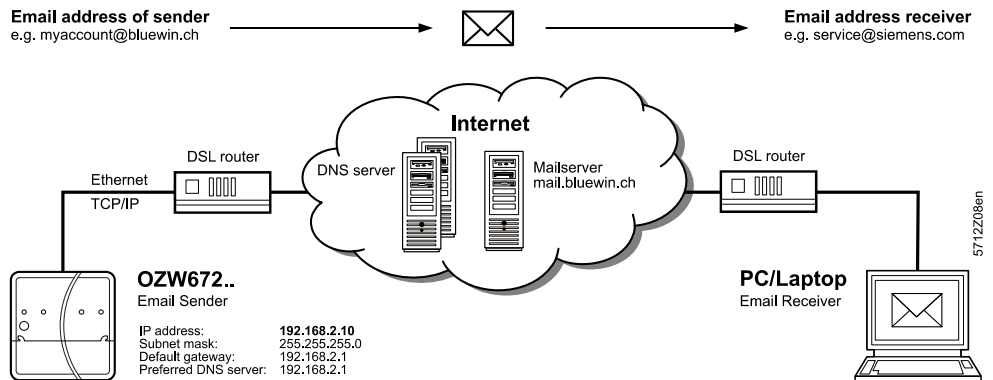

The following applies to send e-mails via the Internet:

- An e-mail account is available and set up.
- Internet access is set up for the web server (see Section 6.1.2).
- The settings for "E-mail", "Message receiver 1...4", "System report" (see Section 2.5.2).

Example mail

```
Von: myhome@bluewin.ch
An: service@siemens.com
Cc:
Betreff: Message central comm unit: My OZW672.16 , Outside sensor error

Device: RVS61.843/109 (1)

Message: Outside sensor error

Fault number: 10

Fault priority: Urgent

Time of occurrence: 24.02.2010; 05:56

Meine| Signatur
```

Messages

The message content is based on pending faults. The following provides an overview of the outline of various e-mail messages. As follows:

- The path for user settings starts each time with:
Home > 0.5 OZW672... > Settings > ...
- Set components of the e-mail are in italics.
- User settings are in **bold**

Web server fault

Example of an e-mail	Data point, information
<i>From:</i> myhome@bluewin.ch	...> Communication > E-mail: E-mail address sender
<i>To:</i> service@siemens.com	...> Message receiver > Message receiver 1...4: E-mail address
<i>Subj:</i> Message central unit: Demo HCS, No bus power supply	Message type: ...> Texts: Name, Fault text
<i>Device:</i> Demo HCS (0.5) Message: No bus power supply. <i>Fault number:</i> 81. Fault priority: Urgent. Occurred at: 15.09.2009 at 08:44	...> Texts: Name (Device address). Fault text Fault code Fault priority Occurred at
myhome.dyndns.info	...> Communication > E-mail: Signature line 1...10

Fault bus device

Example of an e-mail	Data point, information
<i>From:</i> myhome@bluewin.ch	...> Communication > E-mail: E-mail address sender
<i>To:</i> service@siemens.com	...> Message receiver > Message receiver 1...4: E-mail address
<i>Subj:</i> Message central unit: Demo HCS, Outside temperature sensor	Message type: ...> Texts: Name, Fault text
<i>Device:</i> RVS61.843/109 (0,1) Message: Outside temperature sen. <i>Fault number:</i> 10. Fault priority: Urgent. Occurred at: 15.09.2009 at 08:44	...> Texts: Name bus device (Device address). Fault text Fault code Fault priority Occurred at
myhome.dyndns.info	...> Communication > E-mail: Signature line 1...10

Fault inputs 1...2

Example of an e-mail	Data point, information
<i>From:</i> myhome@bluewin.ch	...> Communication > E-mail: E-mail address sender
<i>To:</i> service@siemens.com	...> Message receiver > Message receiver 1...4: E-mail address
<i>Subj:</i> Message central unit: Demo HCS, Overpressure / Pressure normal	Message type: ...> Texts: Name , ...> Faults > Local > Fault input 1...2: Text for: Fault / Text for: No fault
<i>Device:</i> Pressure sensor (Fault input 1) (0.5) <i>Message:</i> Overpressure / Pressure normal Fault number: 171 / 00 Fault priority: Not urgent. Occurred at: 15.09.2009 at 08:44 myhome.dyndns.info	...> Faults > Local > Fault input 1...2: Fault input 1...2 (fault input 1...2) (device address). ...> Faults > Local > Fault input 1...2: Text for: Fault / Text for: No fault Fault code ...> Faults > Local > Fault input 1...2: Fault priority Occurred at ...> Communication > E-mail: Signature line 1...10

Fault eliminated

Example of an e-mail	Data point, information
<i>From:</i> myhome@bluewin.ch	...> Communication > E-mail: E-mail address sender
<i>To:</i> service@siemens.com	...> Message receiver > Message receiver 1...4: E-mail address
<i>Subj:</i> Message central unit: Demo HCS, No fault	Message type: ...> Texts: Name , Fault text
<i>Device:</i> Demo HCS (0.5) <i>Message:</i> No fault. Fault number: 00. Fault priority: Urgent. Occurred at: 15.09.2009 at 08:44 myhome.dyndns.info	...> Texts: Name / Name bus device (Device address). Fault text Fault code Fault priority Occurred at ...> Communication > E-mail: Signature line 1...10

System report with fault

Example of an e-mail	Data point, information
<i>From:</i> myhome@bluewin.ch	...> Communication > E-mail: E-mail address sender
<i>To:</i> service@siemens.com	...> Message receiver > Message receiver 1...4: E-mail address
<i>Subj:</i> Message central unit: Demo HCS, N. OK	Message type: ...> Texts: Name , status
<i>Status:</i> N. OK <i>Fault 1:</i> Device: Demo HCS (0.5) Message: No bus power supply, 81. Occurred at: 15.09.2009 at 08:44 myhome.dyndns.info	Status Fault 1: ...> Texts: Name (Device address), Fault text, fault code Occurred at ...> Communication > E-mail: Signature line 1...10

System report
without fault

Example of an e-mail	Data point, information
<i>From:</i> myhome@bluewin.ch	...> Communication > E-mail: E-mail address sender
<i>To:</i> service@siemens.com	...> Message receiver > Message receiver 1...4: E-mail address
<i>Subj:</i> System report central unit: Demo HCS, OK.	Message type: ...> Texts: Name , status
<i>Status:</i> OK. myhome.dyndns.info	Status ...> Communication > E-mail: Signature line 1...10

MS Outlook

You can provide the required information as follows for an e-mail account under MS Outlook:

1. Start Outlook.
2. Go to *Tools / E-mail accounts...*
3. View or change existing e-mail accounts.
4. Click [Next]
5. Select desired account.
6. Click [Change]

The e-mail account dialog box is displayed with the data on the e-mail account.

7. Click [More Settings]
Displays authentication (if required).

8. Click [Cancel] to exit the account settings.

Notes

-  A list of providers that send e-mails at no charge is available in Section 7.3.2.
- The web server supports HTTPS (Hyper Text Transfer Protocol Secure). E-mails are transmitted unsecured and unencrypted.
- Web server supports SSL (Secure Sockets Layer, network protocol for the secure transfer of data) and TLS (Transport Layer Security, encryption protocol for data transmissions over the Internet; a further development of SSL).
- "Authentication mail server = Yes" checks unsecured, unencrypted information in the data items "User name" and "Password" from the mail server for each e-mail transmission.
- The mail server can also be installed on the local area network.

Empty page

7 Appendix

7.1 General notes

Text entry

Names of data points and message text, e.g. of faults, cannot contain special characters or umlauts. Valid characters:

- a...z and A...Z
- 0...9
- ! , \$ % & , () * + ` - . / : ; < = > ? "Space

Note

 When sent, **invalid characters** will be converted to "?" (question marks).

7.2 Diagnostics

7.2.1 Web server fault codes

Fault codes

Fault code	Web server fault
General	
0	No fault
Communications	
81	No bus power supply ¹⁾
95	Invalid time of day (Web server time not or incorrectly entered).
100	>1 clock time master
142	Device failure (Bus) ²⁾
171	[Fault input 1] fault
172	[Fault input 2] fault
438	Incorrect bus connected
439	Bus module not identified
448	Message receiver 1 not reached ³⁾
449	Message receiver 2 not reached ³⁾
450	Message receiver 3 not reached ³⁾
451	Message receiver 4 not reached ³⁾
System configuration errors	
82	>1 identical device address (Devices have same address).

1) **Device failure** monitoring (**Bus**) is stopped if the bus has no power.

2) Created by the web server for the device failed.

Device failure (Bus) as a result, device failure (bus) is assigned to "System faults", whereas all other faults generated by the web server are assigned as "Local faults".

3) Possible causes of recipient type e-mail: Erroneous Ethernet or e-mail settings.

7.2.2 Windows commander

Windows Commander

You can use the Windows commander to check availability of IP addresses, domains or servers:

1. Open Windows commander: *Start > Run*.
2. Enter "cmd" in the pane.

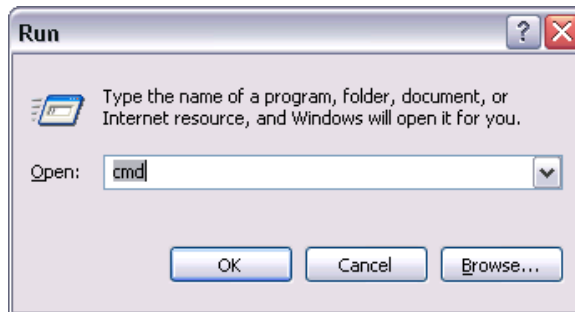

3. Click [OK]
4. Enter the desired command in the command line C:\>:

Command	Result, application
ping <IP address> or <domain>	Response times to the query: Checks whether an IP address can be reached in the network.
Tracert <IP address> or <domain>.	Progress of the IP address implementation to the goal: Check whether DNS and mail servers can be reached.
nslookup <IP address> or <domain>	Translates an IP address to the domain name and vice versa: Look up domain names.

7.3 Communications

7.3.1 Internet protocol

Private networks

The following IP addresses are reserved for private networks:

- Class A: 10.0.0.0–10.255.255.255.
- Class B: 172.16.0.0–172.31.255.255.
- Class C: 192.168.0.0–192.168.255.255 (typical for home networks).

Ports

There are predefined public ports and ranges for private ports:

Public

HTTP 80 HTTPS 443
FTP 21 SMTP 25

Private

Range 49152 to 65535

7.3.2 Free e-mail account providers

You can use free-of-charge e-mail accounts to send e-mails. Note that some ISPs work with encryption or can be accessed and used only via the web server's DSL connection.

Note



The following list is not conclusive, ISPs are subject to change.

Free e-mail account providers				
	Address mail server	Port mail server	Authentication	Restriction
blueVARIA.de	mail.bluevaria.de	25	Yes	
GMX	mail.gmx.net	25, 587	Yes	
Google Mail	smtp.gmail.com	587	Yes	TLS required
Hotmail	smtp.live.com	587	Yes	TLS required
WEB.DE	smtp.web.de	25	Yes	
Yahoo! Mail	smtp.mail.yahoo.com	25	Yes	
Online service provider				
Alice DSL	smtp.alice-dsl.net	25	Yes	
AOL	smtp.de.aol.com	587	Yes	
AOL	smtp.aim.com	587	Yes	
Arcor	mail.arcor.de	25	Yes	
CompuServe	smtp.compuserve.de	25	Yes	
Freenet	mx.freenet.de	25	Yes	
T-Online	smtpmail.t-online.de	25	Yes	

Additional information on free e-mail providers:

- http://www.patshaping.de/hilfen_ta/pop3_smtp.htm
- <http://www.iopus.com/guides/bestpopsntp.htm>

Note



[Siemens is not responsible for third-party page contents.](#)

7.3.3 Install RNDIS driver

RNDIS driver

The PC requires a USB RNDIS driver for the connection between the PC and the web server.

Windows hardware recognition recognizes the web server when the USB cable is plugged into the USB cable. You can start the Add Hardware Wizard if no RNDIS driver is installed.

The driver is installed in the background using an Internet connection. You can install the driver manually without an Internet connection.

Note



The operating system must be equipped with the latest updates.

Automatic installation

Procedure:

1. Select "Search for and install the hardware automatically (Recommended)".



2. Click [Next >]
The software is installed.
3. Confirm hardware installation:
Click [Continue installation]
4. Wait until installation is complete and click [Finish]



Result

The RNDIS driver is now installed.
The PC can communicate with the web server via USB.

Manual installation

The RNDIS driver is supplied on the web server at <http://<IP address>/drivers/> can be accessed via Ethernet connection (see Section 2.6.1).

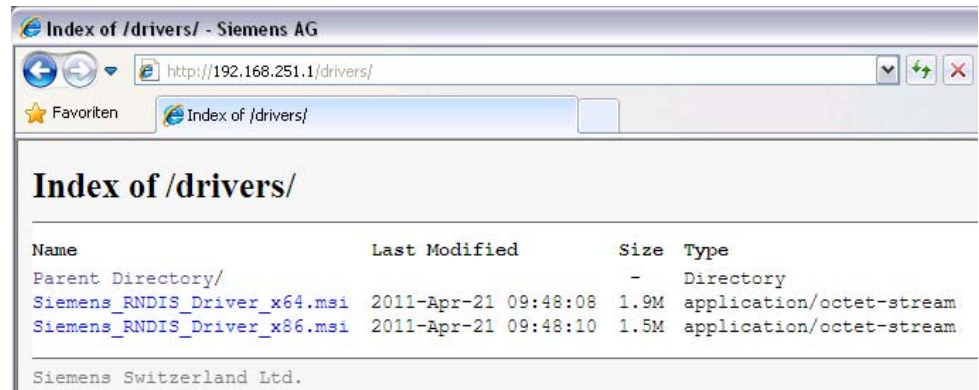

The driver Siemens_RNDIS_Driver_x64.msi is installed on a 64-bit operating system; on a 32-bit operating system Siemens_RNDIS_Driver_x86.msi. The installation file for the driver can be executed directly on the PC. Following the steps for the installation wizard.

Result

The RNDIS driver is now installed.
The PC can communicate with the web server via USB.

Note

 The RNDIS driver is installed as part of the ACS790 Siemens software installation.

7.3.4 Alternative network configuration

Alternative configuration

We recommend setting up IP settings for commissioning as an alternative configuration if a PC, connected to a network, is temporarily used to commission the web server and the local area network.

On the PC, set as follows:

1. *Select Start > Control Panel > Network Connections > Local Area Connection*
2. Select the "General" tab.

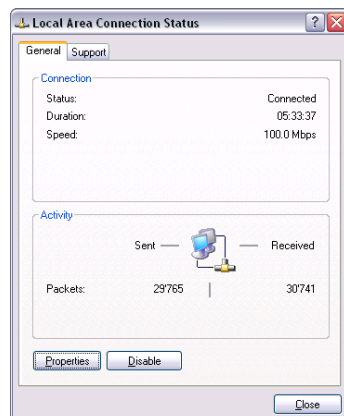

3. Click [Properties]

Continued on next page.

4. Select "Internet Protocol (TCP/IP)".

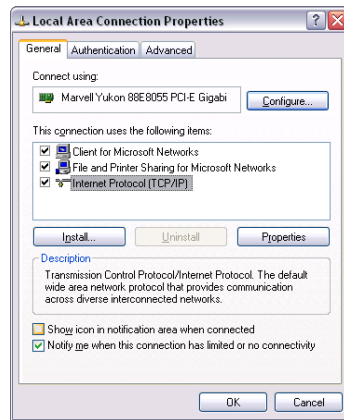

5. Click [Properties]
6. Select "Alternate Configuration" tab.
7. Enter IP address, subnet mark and operational standard gateway as well as DNS server.

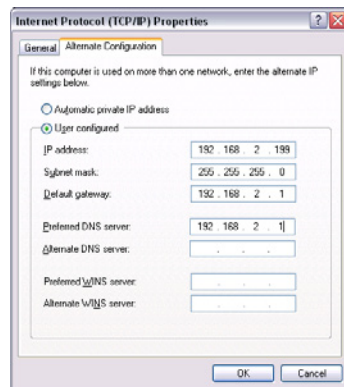

Result

The PC assumes the configuration with these settings as soon as it is no longer integrated in the standard network.

7.3.5 Siemens routers

We recommend the following router from Siemens to connect to an internal network with DSL connection:

We recommend the **Gigaset SX763 WLAN dsl** by Siemens. This router supports all requirements for trouble-free operation of web server.



Performance features

- 1 connection for analog, leased line network.
- 2 internal connections for analog devices (phone, fax, answering machines).
- Integrated phone system for up to 6 extensions (analog, LAN, WLAN).
- 4 Ethernet ports to network PC or other LAN.
- WLAN (IEEE 802.11b/g) with variable reduction of WLAN transmission.
- 6 VoIP accounts can be configured.
- USB 2.0 host connection for printer or external storage media.
- Ready for connection to home entertainment services.
- Remote management.
- Integrated SIP proxy.
- Security and firewall functionality.
- Easy installation and setup.

Technical data

Protocols / Service

TCP/IP, UDP, DHCP server/client, HTTP/ HTTPS, DNS, RIPv1/v2, Telnet, UPnP, IGMP, NTP, port forwarding, DynDNS, preconfigured gateways, backup, NAT, URL/port filter, DoS blocking, packet inspection, firewall, WPA2, WPA, 64/128-bit WEP encryption, SSID broadcast can be deactivated, Mac filter.

High-speed WLAN gateway for triple play services: Supports Internet, home entertainment, leased line and VoIP.

DoS attack

Denial of Service

When buying routers, make sure they can defend against DoS attacks

(function is available on most commercially available routers).

A DoS attack is a special type of hacker attack on computers and networks with connection to the Internet.

7.4 Glossary of Ethernet and Internet terms

ADSL	<p>Upstream and downstream channel transport data at different rates, i.e. asymmetrically via a two-wire line (DLS, copper phone line) on a broadband network.</p> <p>Very little data is sent upstream, i.e. to the server, when surfing. The requested data, however, are sent at high speed downstream to the requesting computer. You can call or e.g. send faxes while transmitting data.</p> <p>The Internet Service Provider ISP provides the ADSL connection. You need a DSL modem for this type of connection.</p>
Asymmetrical Digital Subscriber Line	<p>See <i>ADSL</i></p>
Bit rate	<p>The bit rate describes the transmission speed or rate in bits per second (bps).</p>
Broadcast	<p>Data sent out to all participants on the network.</p>
Client	<p>A client is a network device unable to execute certain services and thus requests those services from the server. The server provides the service and sends a reply.</p>
Default gateway	<p>Gateway that is selected when one IP address is outside its own subnet and therefore the standard gateway is unknown.</p>
Denial of Service	<p>See <i>DoS attack</i></p>
DHCP	<p>The new Dynamic Host Configuration Protocol allows for dynamic allocation of a network configuration to clients (PC, web server) via a server (router).</p>
Digital Subscriber Line	<p>see <i>DSL</i></p>
DNS	<p>The DNS allows for assigning IP addresses to names (that are easier to remember than 32-bit IP addresses). A DNS server must manage this information for each LAN with Internet connection. When you select an Internet page, the web browser accesses the IP address of that site assigned by the DNS server to open a connection.</p> <p>On the Internet, domain names are assigned to IP addresses as per a hierarchical system. A local PC only knows the address of the local DNS server. This server, in turn, knows the addresses of all PCs on the local network as well as that of the higher DNS servers that, in turn, know the addresses of the next higher DNS servers.</p>
Domain name	<p>The domain name is the web server designation on the Internet. The DNS server assigns an IP address to the domain name.</p>
Domain Name System	<p>See <i>DNS</i></p>
DoS attack	<p>A DoS attack (denial of service) is a special type of hacker attack on computers and networks connected to the Internet. The DoS attack aims at disabling computers and networks to prevent network resources from being provided and services from being executed.</p>

DSL	DSL is a type of data transmission allowing for 1.5 Mbps access to the Internet on standard copper phone lines. The Internet Service Provider ISP provides the DSL connection. You need a DSL modem for this type of connection.
DSL router	The DSL router has several functions. It connects the Ethernet network (LAN) and the internal network devices to the Internet. The router then requests the IP addresses for the internal network devices from the DNS server. Port forwarding (NAT, PAT) is also configured in the router. In addition, service "DynDNS", which automatically is updated after a change of the DynDNS server, is activated in the router.
Dynamic DNS	See <i>DynDNS</i>
Dynamic Host Configuration Protocol	See <i>DHCP</i>
Dynamic IP address	<p>A dynamic IP address is assigned automatically via DHCP to a network device. As a result, the IP address for a network device differs every time the device logs in or at periodic intervals.</p> <p>The ISP assigns dynamic IP addresses to network devices that are not online continuously, i.e. integrated in the network. Dynamic IP addresses are reassigned to other devices, as the number of addresses is limited. Web server (permanently online) does not use a dynamic IP address.</p>
DynDNS	<p>The DNS server assigns domain names and IP addresses. Dynamic DNS (DynDNS) is needed for dynamic IP addressing. It allows deployment of a network device with dynamic IP address on the Internet.</p> <p>DynDNS ensures that a service is always available on the Internet under the same domain name regardless of the current IP address.</p> <p>A domain name can be registered with a DynDNS service.</p>
Ethernet	Ethernet is a network technology for local networks (LAN). Ethernet operates at a transmission rate of 10 or 100 Mbps and has a maximum range of 100 meters between two network components.
Firewall	A firewall protects networks against unauthorized access from the outside. Firewalls are hardware and/or software measures designed to control data exchange between the private network to be protected and an unsecured network (e.g. the Internet).
Gateway	A gateway is a device connecting networks of different architecture (addressing, protocols, interfaces, etc.). Although not entirely correct, the term often is used interchangeably with router.
HTTP proxy	A proxy is a server used by network devices for Internet traffic. All requests are sent via the proxy server.
HTTPS	The web server supports HTTPS (Hyper Text Transfer Protocol Secure).
Hub	A hub in a star-topology network connects various network devices by receiving all data from one device and forwarding it to other devices.

Hyper Text Transfer Protocol Secure	See <i>HTTPS</i>
Internet	<p>The Internet is a data network with millions of members. A number of protocols are used to exchange data, summarized under the term TCP/IP.</p> <p>All devices connected to the Internet can be identified via IP address. The DNS server assigns domain names to IP addresses.</p>
Internet Protocol	See <i>IP</i>
Internet Service Provider	See <i>ISP</i>
IP	<p>The IP protocol is a TCP/IP protocol. It is responsible for addressing devices on a network based on IP addresses and transmitting data packages from sender to recipient. The IP protocol determines the order and network connection used to send data packages (routing).</p> <p>The transmission control protocol TCP reassembles the data packages in the right order at the recipient.</p>
IP address	<p>The IP address is a unique address of a network device on the network based on TCP/IP protocols. The IP address consists of four sections, separated by a dot (192.168.1.1).</p> <p>The IP address comprises the network number and the computer number (number of the network device). Depending on the subnet mask, one, two or three portions form the network or computer number.</p> <p>IP addresses can be assigned automatically or manually. On the Internet, domain names are used rather than IP addresses. The DNS server assigns domain names to IP addresses.</p>
IP address pool	IP address pool defined at the router (IP address range) the DHCP server can be used to assign dynamic IP addresses.
LAN	A local network (size: large building, building sites) is a number of interconnected network devices. In LANs, data is exchanged and resources are used jointly. A LAN can be connected to other networks such as WAN or Internet.
Local Area Network	See <i>LAN</i>
MAC address	The MAC address allows for worldwide identification of a network adapter (network card). It consist of hexadecimal numbers, grouped in six portions at 2x4 bit each, thus 48 bit, e.g. 00-55-96-5D-00-2C. The MAC address is assigned by the network adapter manufacturer and cannot be changed.
Mbps	Million bits per second indicates the transmission rate in a network.
Media Access Control	See <i>MAC address</i>

NAT	<p>NAT is a method to translate IP addresses (private IP addresses) in a network into one or several public IP addresses on the Internet. NAT allows us to use several network devices in a LAN together with a public IP address of a router for Internet access.</p> <p>The network devices of the local network are masked by the IP address (router) registered on the Internet. Thanks to this security function, NAT often is used as a part of a network's firewall. Web server is accessible from a public network thanks to the correct NAT table definition; see also port forwarding.</p>
Network	A network (LAN, WAN) is a linked group of devices connected via various lines or radio sharing common resources such as data or peripheral devices.
Network adapter	Hardware to connect network components to a local area network (LAN). Connection can be wired or wireless.
Network Address Translation	See <i>NAT</i>
Network configuration	All settings an IP-based device requires to work on a network: IP address, subnet mask, standard gateway, preferred DNS server, and alternate DNS server.
PAT	PAT or NPAT (Network and Port Address Translation) translates all private network addresses into one public (dynamic) IP address. In this process, port numbers are exchanged in addition to addresses when there is a connection. As a result, an entire private network only requires one single registered public IP address.
Plant room	The ISP provides the connection to the Internet via DSL or cable TV (at a fee).
Point-to-Point Protocol	See <i>PPP</i>
Port	<p>Ports are used to exchange data between different applications on a network. The port number addresses the application within a network device. The combination of IP address and port number serves as a unique identification of the recipient or the sender of the data package with the network.</p> <p>Internet service applications work with set port numbers (HTTP 80, FTP 21). See http://www.iana.org/assignments/port-numbers for registered port numbers. Port numbers 0 to 49151 are set and reserved, port numbers 49152 to 65535 are dynamic (and therefore available).</p>
Port and Address Translation	See <i>PAT</i>
Port Forwarding	With port forwarding, the router forwards data packages from the Internet, destined for a particular port, to the port of the responsible network device. As a result, servers (web server) integrated in a LAN, can be reached from the Internet (without a need for a public IP address). Port Forwarding is achieved by the correct NAT / PAT definition in the router.
PPP	Protocol for dial-up connection of a computer to the ISP.
PPP over Ethernet	See <i>PPPoE</i>

PPPoE	Protocol used to connect to the Internet via ADSL or DSL.
Private IP address	<p>The private IP address (local IP address) is the address of a network device on a local network (LAN). The provider assigns this address at will. DSL routers have a public IP address for the WAN and a private IP address for the LAN. The following IP ranges are recommended for private IP addresses:</p> <p>10.0.0.0...10.255.255.255 → Class A. 172.16.0.0...172.31.255.255 → Class B. 192.168.0.0...192.168.255.255 → Class C.</p> <p>The first IP address xxx.xxx.xxx.0 and the last IP address xxx.xxx.xxx.255 in a network segment cannot be used, as xxx.xxx.xxx.0 is reserved for the network and xxx.xxx.xxx.255 for broadcasting.</p>
Protocol	A protocol describes the type of communication on a network. It contains rules on opening, managing, and closing a connection, on data formats, time sequences, and possible error correction. Different protocols are needed to allow two applications at different levels to communicate with each other, e.g. TCP/IP protocols on the Internet.
Provider	Provider of telecommunications services. Also referred to as network provider or network operator.
Public IP address	<p>The public IP address is the worldwide valid (global) address of a network device on the Internet. The ISP assigns these addresses. A network device with public IP address is a device establishing a connection between local network LAN and the Internet.</p> <p>DSL routers have a private IP address for the LAN and a public IP address for the WAN (Internet).</p>
Router	A router forwards data packages from a local network LAN to a higher network while selecting the fastest route. A router allows for connecting different networks with different network topologies. For example, the router connects a local network to the Internet.
Secure Sockets Layer	See <i>SSL</i>
Server	A server accepts requests from clients, processes them and responds to the clients. Network servers, data servers, web servers also assume services for other network devices.
Simple Mail Transfer Protocol	See <i>SMTP</i>
SMTP	The SMTP protocol is a TCP/IP protocol. It controls e-mail traffic on the Internet. The ISP provides the SMTP server (mail server).
SSL	Outdated form for TLS; see TLS.
Standard gateway	A standard gateway (see also DSL router) is also referred to as a network address used by clients to send their packages if the target address is outside the immediate network.

Static IP address	<p>Network devices, and servers in particular, integrated permanently in a network, have static IP addresses. Clients often have a dynamic IP address.</p> <p>Web server (integrated permanently in a network) has a static IP address and can thus be reached easily by clients.</p>
Subnet	A subnet subdivides a network into smaller network segments.
Subnet mask	<p>A subnet mask masks the IP address, i.e. it determines which parts of the IP address form the network number and which parts the computer number (e.g. server).</p> <p>Subnet mask 255.255.255.0 means that the first three sections of the IP address determine the network number, and the fourth section is used for the computer number. In this case, the first three IP address sections are identical for all network devices. Example:</p> <p>Subnet mask 255.255.255.0 masks IP addresses: 192.168.1.1...192.168.1.254.</p> <p>Please note: Do not use the first IP address 192.168.1.0 and last IP address 192.168.1.255.</p>
Switch	A switch, similar to a hub, is a connecting element to connect various network segments or network devices. Contrary to the hub, a switch is an intelligent device used to route packages only to the subnet or network device for which a package is destined.
TCP	<p>The TCP protocol is a TCP/IP protocol. TCP is responsible for transporting data between two communication partners (applications). TCP is a secured transmission protocol, i.e. a connection is established, monitored and disconnected to data transmission.</p> <p>TCP is a so-called connection-oriented protocol. The transmission control protocol TCP reassembles the data packages, sent by the Internet protocol IP via different network connections, in the right order at the recipient.</p>
TCP/IP	Family of protocols used as the basis for the Internet. TCP/IP for the basis for any number of internet services such as HTTP (Web), FTP (file transfer) and SMTP (mail).
TLS	<p>TLS (Transport Layer Security, for [outdated]: SSL Secure Sockets Layer) a hybrid encryption protocol to transmit data over the Internet. TLS 1.0, 1.1 and 1.2 are standardized developments of SSL 3.0 (TLS 1.0 is now used for SSL 3.1). In other words, SSL is being further developed under the name TLS.</p> <p>The web server always uses TLS for e-mails to the extent supported by the e-mail provider supports.</p>
Transmission Control Protocol	See <i>TCP</i>
Transport Layer Security	See <i>TLS</i>
UDP	UDP is a TCP/IP protocol to control data traffic between two communication partners (application). UDP, in contrast to TCP, is an unsecured protocol. UCP is a so-called connection-less protocol. Data packets are broadcast. The recipient is responsible for receiving data. The sender does not receive notification if the data packages were received.

Uniform Resource Locator	<i>See URL</i>
Universal Plug and Play	<i>See UPnP</i>
UPnP	UPnP technology was designed for home and office networks. Devices supporting UPnP automatically configure their network settings as soon as connected to a network. In addition, they automatically provide, depending on class, own services or use services of other devices on the network.
URL	A URL refers to an information source, e.g. http://www.siemens.com . The URL is a uniform web address that is used to determine the network protocol used (e.g. http) or the location of the resource on the network.
User Datagram Protocol	<i>See UDP</i>
WAN	The wide area network WAN has a spatial dimension of ca. 50 km. A WAN can comprise a number of several LANs. If an ISP operates a WAN, private LAN users receive access to the Internet.
Wide Area Network	<i>See WAN</i>
Wireless LAN	<i>See WLAN</i>
WLAN	Wireless LANs allow network devices to communicate via radio. The WALN can be added as an extension to a wired LAN, or it can be the basis of a new network.

Index

A

Abbreviations	12
Activate Energy indicator function	75
Address Translation (NAT).....	90
Administer user accounts	16
Alternative network configuration	103

B

Bus device operation	41
----------------------------	----

C

Commissioning	
Create device list.....	18
Final steps	37
Functional check	34
LAN	32
Log into web server	15
Message recipient	30
Network components	32
Prep web server	14
Prerequisites	13
Router settings	33
Settings	23
Communication	
Email	93
LAN	85
Remote control.....	85
Create own plant web pages	59

D

Deactivate Energy indicator function	
Confirmation message	74
Data point monitoring	73
Green limits to default values	74
Monitoring off.....	74
Summary checkbox.....	74
Device Description.....	65
Device information	44
Ethernet.....	46
LPB / BSB	45
Dialog box Energy indicator	
Data point value	77
Enumeration data points	79
General.....	77
Green limit(s).....	78
Numeric data points	78
Setting range	77
Display and operating elements	8
DynDNS	92

E

E-mail Energy indicator	
Configure E-mail receiver	80
Contents.....	82
Energy indicator of plant.....	80
Mailbox.....	81
Energy indicator	
Green leaf	63
Grey leaf	63
Orange leaf	63
Summary display	71
Temporary status	72
Visibility	70
Energy indicator function, Data point monitoring ..	75

F

Fault codes	99
Faults current local	47
Faults, Message triggering	28
Firewall	90
Function Energy indicator	
Commissioning	72
Estimated processing time.....	73
Monitored data points and green limit(s)	63
Number of monitored data points	69
User groups service and end user.....	79

G

Glossary	106
----------------	-----

H

HIT.....	57
----------	----

I

Install RNDIS driver, Automatically.....	102
Invalid characters	99

L

Levels Energy indicator function	
Data points	68
Partial plants	67
Plant.....	66

M

Message recipient	
Holidays/special days	31, 44
Monday...Sunday, special day	30, 43

O	
Operate the plant	41
Operate&monitor.....	53
Operation	
Faults.....	47
File transfer	48
Overview	39
P	
Plant diagrams.....	57
Plant state Energy indicator	
Green leaf.....	71
Orange leaf.....	71
Summary display.....	71
Plant web page (example)	54
Plant web pages	53
Port Forwarding (PAT)	91
Primary navigation	9
R	
Remote operation via the Internet	89
S	
Secondary navigation	9
Settings	
Email	
Email address sender	26
Mail server address	26
Mail server port number.....	26
Ethernet	
IP address.....	24
Subnet mask.....	24
Fault input 1...2	28
LPB / BSB, Clock time supplier	24
Message recipients 1 to 4	27
Time/Date	22
Daylight saving time	23
Time zone	23
Web server, Language.....	23
Standard applications	57
Start Function Energy indicator	72
Summary checkbox Energy indicator.....	74
Summary display Energy indicator.....	71
Supply state.....	38
Symbols.....	11
System faults	47
System report	27
T	
Terms.....	106
Text entry	99
Time/date.....	22
Tree leaf as Energy indicator.....	63
U	
UPnP localization	26
User levels.....	10
V	
Valid characters	99
Visibility Energy indicator.....	70
Visualize	53
W	
Web operation, user interface	9
Web page	
Energy indicator function	64
Energy indicator update.....	72
Web server diagnostics	44
Web server faults.....	47
Web server operation	41

Siemens Switzerland Ltd
Infrastructure & Cities Sector
Building Technologies Division
Gubelstrasse 22
CH-6301 Zug
Tel. +41 41-724 24 24
www.siemens.com/sbt

© 2010-2012 Siemens Switzerland Ltd
Subject to change